

TGS 2610-C00 - for the detection of LP Gas

Features:

- * Quick response
- * Low power consumption
- * Long life and low cost
- * Uses simple electrical circuit

Applications:

- * Portable LP gas detectors
- * LP gas and vapor detection

TGS2610-C00 is a semiconductor type gas sensor which combines very high sensitivity to LP gas with low power consumption and long life. Due to miniaturization of its sensing chip, TGS2610-C00 requires a heater current of only 56mA and the device is housed in a standard TO-5 package.

TGS2610-C00 possesses small size and quick gas response, making it suitable for gas leakage checkers.

The TGS2610-C00 is able to satisfy the requirements of performance standards such as UL1484 and EN50194.

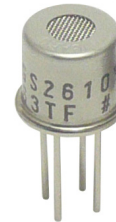

The figure below represents typical sensitivity characteristics, all data having been gathered at standard test conditions (see reverse side of this sheet). The Y-axis is indicated as sensor resistance ratio (R_s/R_o) which is defined as follows:

- R_s = Sensor resistance at various concentrations
- R_o = Sensor resistance in 1800ppm of iso-butane

Sensitivity Characteristics:

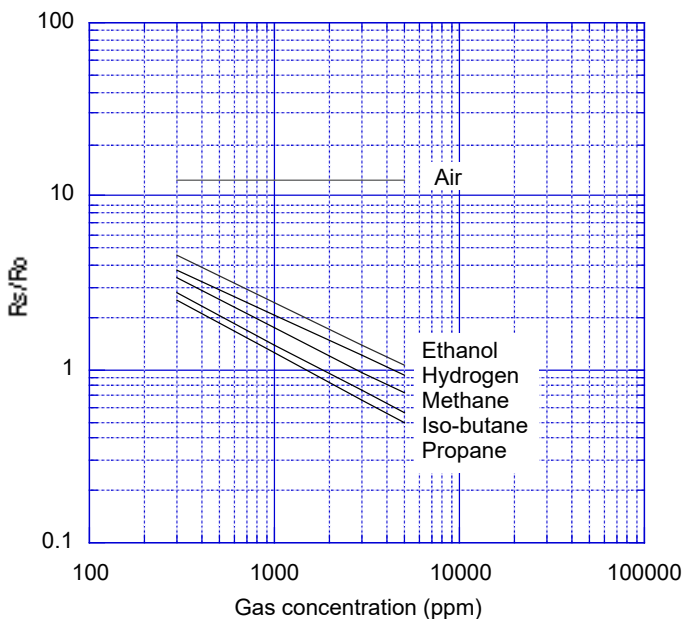

The figure below represents the typical response pattern when the sensor is inserted into and later removed from 1800ppm of iso-butane.

Gas Response to Iso-butane:

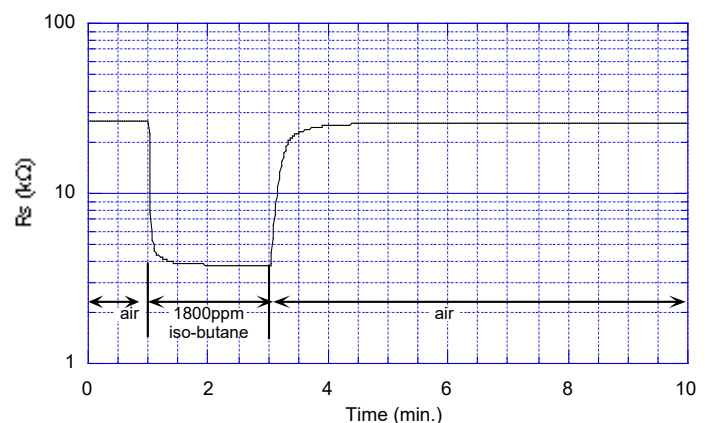

IMPORTANT NOTE: OPERATING CONDITIONS IN WHICH FIGARO SENSORS ARE USED WILL VARY WITH EACH CUSTOMER'S SPECIFIC APPLICATIONS. FIGARO STRONGLY RECOMMENDS CONSULTING OUR TECHNICAL STAFF BEFORE DEPLOYING FIGARO SENSORS IN YOUR APPLICATION AND, IN PARTICULAR, WHEN CUSTOMER'S TARGET GASES ARE NOT LISTED HEREIN. FIGARO CANNOT ASSUME ANY RESPONSIBILITY FOR ANY USE OF ITS SENSORS IN A PRODUCT OR APPLICATION FOR WHICH SENSOR HAS NOT BEEN SPECIFICALLY TESTED BY FIGARO.

Basic Measuring Circuit:

The sensor requires two voltage inputs: heater voltage (V_H) and circuit voltage (V_C). The heater voltage (V_H) is applied to the integrated heater in order to maintain the sensing element at a specific temperature which is optimal for sensing. Circuit voltage (V_C) is applied to allow measurement of voltage (V_{OUT}) across a load resistor (R_L) which is connected in series with the sensor.

A common power supply circuit can be used for both V_C and V_H to fulfill the sensor's electrical requirements. The value of the load resistor (R_L) should be chosen to optimize the alarm threshold value, keeping power dissipation (P_S) of the semiconductor below a limit of 15mW. Power dissipation (P_S) will be highest when the value of R_S is equal to R_L on exposure to gas.

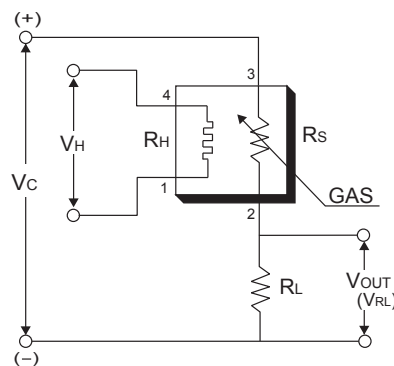

Specifications:

Model number		TGS2610-C00	
Sensing principle		MOS type	
Standard package		TO-5 metal can	
Target gases		Butane, LP gas	
Typical detection range		1~25% LEL	
Standard circuit conditions	Heater voltage	V_H	5.0±0.2V AC/DC
	Circuit voltage	V_C	5.0±0.2V DC $P_S \leq 15mW$
	Load resistance	R_L	variable 0.45kΩ min.
Electrical characteristics under standard test conditions	Heater resistance	R_H	approx 59Ω at room temp.
	Heater current	I_H	56±5mA
	Heater power consumption	P_H	280mW $V_H=5.0V$ DC
	Sensor resistance	R_S	1.0~10.0kΩ in 1800ppm iso-butane
	Sensitivity (change ratio of R_S)		0.45~0.62 in iso-butane $\frac{R_S(3000ppm)}{R_S(1000ppm)}$
Standard test conditions	Test gas conditions	iso-butane in air at 20±2°C, 65±5%RH	
	Circuit conditions	$V_C = 5.0 \pm 0.01V$ DC $V_H = 5.0 \pm 0.05V$ DC	
	Preheating period before test	7 days	

Structure and Dimensions:

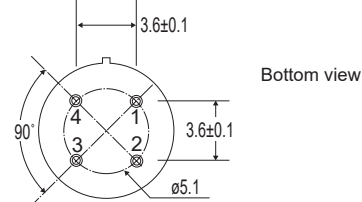
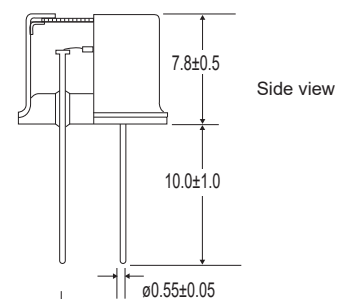
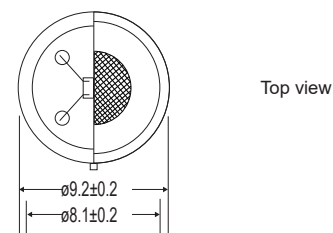

u/m:mm

The value of power dissipation (P_S) can be calculated by utilizing the following formula:

$$P_S = \frac{(V_C - V_{RL})^2}{R_S}$$

Sensor resistance (R_S) is calculated with a measured value of $V_{OUT}(V_{RL})$ by using the following formula:

$$R_S = \left(\frac{V_C}{V_{RL}} - 1 \right) \times R_L$$

Pin connection:

- 1: Heater
- 2: Sensor electrode (-)
- 3: Sensor electrode (+)
- 4: Heater

For information on warranty, please refer to Standard Terms and Conditions of Sale of Figaro USA Inc. All sensor characteristics shown in this brochure represent typical characteristics. Actual characteristics vary from sensor to sensor. The only characteristics warranted are those in the Specification table above.

REV: 04/21

Before purchasing this product, please read the Warranty Statements shown in our webpage by scanning this QR code.



https://figarosensor.com/pdf/Figaro_USA_Sales_T&C.pdf

FIGARO USA, INC.

121 S. Wilke Rd. Suite 300
Arlington Heights, Illinois 60005
Phone: (847)-832-1701
Fax: (847)-832-1705
email: figarousa@figarosensor.com