

AD7896*

FEATURES

- 100 kHz Throughput Rate**
- Fast 12-Bit Sampling ADC with 8 μ s Conversion Time**
- 8-Pin Mini-DIP and SOIC**
- Single +2.7 V to +5.5 V Supply Operation**
- High Speed, Easy-to-Use, Serial Interface**
- On-Chip Track/Hold Amplifier**
- Analog Input Range is 0 V to Supply**
- High Input Impedance**
- Low Power: 9 mW typ**

FUNCTIONAL BLOCK DIAGRAM

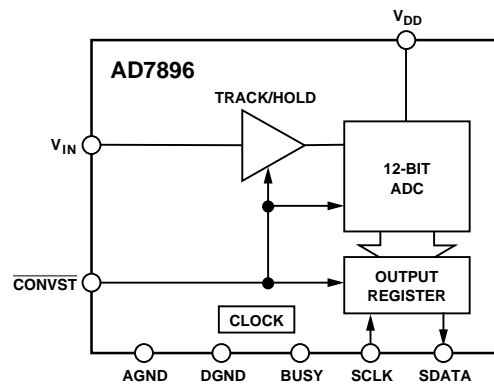

GENERAL DESCRIPTION

The AD7896 is a fast, 12-bit ADC which operates from a single +2.7 V to 5.5 V supply and is housed in a small 8-pin mini-DIP and 8-pin SOIC. The part contains an 8 μ s successive approximation A/D converter, an on-chip track/hold amplifier, an on-chip clock and a high speed serial interface.

Output data from the AD7896 is provided via a high speed, serial interface port. This two-wire serial interface has a serial clock input and a serial data output with the external serial clock accessing the serial data from the part.

In addition to the traditional dc accuracy specifications such as linearity, full-scale and offset errors, the AD7896 is also specified for dynamic performance parameters including harmonic distortion and signal-to-noise ratio.

The part accepts an analog input range of 0 V to V_{DD} and operates from a single +2.7 V to +5.5 V supply consuming only 9 mW typical. The V_{DD} input is also used as the reference for the part so that no external reference is required.

The AD7896 features a high sampling rate mode and, for low power applications, a proprietary automatic power down mode where the part automatically goes into power down once conversion is complete and "wakes up" before the next conversion cycle.

The part is available in a small, 8-pin, 0.3" wide, plastic or hermetic dual-in-line package (mini-DIP) and in an 8-pin, small outline IC (SOIC).

*Patent pending.

REV. B

Information furnished by Analog Devices is believed to be accurate and reliable. However, no responsibility is assumed by Analog Devices for its use, nor for any infringements of patents or other rights of third parties which may result from its use. No license is granted by implication or otherwise under any patent or patent rights of Analog Devices.

PRODUCT HIGHLIGHTS

1. Complete, 12-bit ADC in 8-Pin Package
The AD7896 contains an 8 μ s ADC, a track/hold amplifier, control logic and a high speed serial interface, all in an 8-pin DIP. The V_{DD} input is used as the reference for the part so no external reference is needed. This offers considerable space saving over alternative solutions.
2. Low Power, Single Supply Operation
The AD7896 operates from a single +2.7 V to 5.5 V supply and consumes only 9 mW typical. The automatic power down mode, where the part goes into power down once conversion is complete and "wakes up" before the next conversion cycle, makes the AD7896 ideal for battery powered or portable applications.
3. High Speed Serial Interface
The part provides high speed serial data and serial clock lines allowing for an easy, two-wire serial interface arrangement.

AD7896—SPECIFICATIONS ($V_{DD} = +2.7\text{ V to }+5.5\text{ V}$, $AGND = DGND = 0\text{ V}$. All specifications T_{MIN} to T_{MAX} unless otherwise noted)

Parameter	A Versions ¹	B Versions	J Version	S Version	Units	Test Conditions/Comments
DYNAMIC PERFORMANCE ²						
Signal to (Noise + Distortion) Ratio ³ @ +25°C T_{MIN} to T_{MAX}	70	70 70	70 typ	70	dB min	$f_{IN} = 10\text{ kHz Sine Wave}$, $f_{SAMPLE} = 100\text{ kHz}$
Total Harmonic Distortion (THD) ³	-80	-80	-80 typ	-80	dB max	$f_{IN} = 10\text{ kHz Sine Wave}$, $f_{SAMPLE} = 100\text{ kHz}$
Peak Harmonic or Spurious Noise ³	-80	-80	-80 typ	-80	dB max	$f_{IN} = 10\text{ kHz Sine Wave}$, $f_{SAMPLE} = 100\text{ kHz}$
Intermodulation Distortion (IMD) ³ 2nd Order Terms	-80	-80	-80 typ	-80	dB max	$f_a = 9\text{ kHz}$, $f_b = 9.5\text{ kHz}$, $f_{SAMPLE} = 100\text{ kHz}$
3rd Order Terms	-80	-80	-80 typ	-80	dB max	
DC ACCURACY						
Resolution	12	12	12	12	Bits	
Minimum Resolution for which No Missing Codes are Guaranteed	12	12	12	12	Bits	
Relative Accuracy ³	±1	±1/2	±1	±1	LSB max	
Differential Nonlinearity ³	±1	±1	±1	±1	LSB max	
Positive Full-Scale Error ³	±3	±1.5	±3	±3	LSB max	
Unipolar Offset Error	±4	±4	±5	±4	LSB max	$V_{DD} = 5\text{ V} \pm 10\%$
	±4	±3	±5	±4	LSB max	$V_{DD} = 2.7\text{ V to }3.6\text{ V}$
ANALOG INPUT						
Input Voltage Range	0 to + V_{DD}	0 to + V_{DD}	0 to + V_{DD}	0 to + V_{DD}	Volts	
Input Current	±2	±2	±2	±5	µA max	
LOGIC INPUTS						
Input High Voltage, V_{INH}	2.0 2.4	2.0 2.4	2.0 2.4	2.0 2.4	V min	$V_{DD} = 2.7\text{ V to }3.6\text{ V}$ $V_{DD} = 5\text{ V} \pm 10\%$
Input Low Voltage, V_{INL}	0.8	0.8	0.8	0.8	V max	
Input Current, I_{IN}	±10	±10	±10	±10	µA max	$V_{IN} = 0\text{ V to }V_{DD}$
Input Capacitance, C_{IN} ⁴	10	10	10	10	pF max	
LOGIC OUTPUTS						
Output High Voltage, V_{OH}	2.4	2.4	2.4	2.4	V min	$I_{SOURCE} = 2\text{ mA}$
Output Low Voltage, V_{OL}	0.4	0.4	0.4	0.4	V max	$I_{SINK} = 2\text{ mA}$
Output Coding	Straight (Natural) Binary					
CONVERSION RATE						
Conversion Time:						
Mode 1 Operation	8	8	8	8.5	µs max	
Mode 2 Operation ⁵	14	14	14	14.5	µs max	
Track/Hold Acquisition Time ³	1.5	1.5	1.5	1.5	µs max	
POWER REQUIREMENTS						
V_{DD}	+2.7/+5.5	+2.7/+5.5	+2.7/+5.5	+2.7/+5.5	V min/max	
I_{DD}	4	4	4	4	mA max	Digital Input @ $DGND$, $V_{DD} = 2.7\text{ V to }3.6\text{ V}$
	5	5	5	5	mA max	Digital Inputs @ $DGND$, $V_{DD} = 5\text{ V} \pm 10\%$
Power Dissipation	10.8	10.8	10.8	10.8	mW max	$V_{DD} = 2.7\text{ V}$, Typically 9 mW
Power-Down Mode						Digital Inputs @ $DGND$
I_{DD} @ +25°C	5	5	5 µA typ	5	µA max	$V_{DD} = 2.7\text{ V to }3.6\text{ V}$
T_{MIN} to T_{MAX}	15	15	75	75	µA max	$V_{DD} = 2.7\text{ V to }3.6\text{ V}$
I_{DD} @ +25°C	50	50	50	50	µA max	$V_{DD} = 5\text{ V} \pm 10\%$
T_{MIN} to T_{MAX}	150	150	500	500	µA max	$V_{DD} = 5\text{ V} \pm 10\%$
Power Dissipation @ +25°C	13.5	13.5	13.5	13.5	µW max	$V_{DD} = 2.7\text{ V}$

NOTES

¹Temperature ranges are as follows: A, B Versions: -40°C to +85°C; J Version: 0°C to +70°C; S Version: -55°C to +125°C.

²Applies to Mode 1 operation. See section on operating modes.

³See Terminology.

⁴Sample tested @ +25°C to ensure compliance.

⁵This 14 µs includes the “wake-up” time from standby. This “wake-up” time is timed from the rising edge of \overline{CONVST} , whereas conversion is timed from the falling edge of \overline{CONVST} , for narrow \overline{CONVST} pulse width the conversion time is effectively the “wake-up” time plus conversion time hence 14 µs. This can be seen from Figure 3. Note that if the \overline{CONVST} pulse width is greater than 6 µs then the effective conversion time will increase beyond 14 µs.

Specifications subject to change without notice.

TIMING CHARACTERISTICS¹ ($V_{DD} = +2.7\text{ V to }+5.5\text{ V}$, $AGND = DGND = 0\text{ V}$)

Parameter	A, B Versions	J Version	S Version	Units	Test Conditions/Comments
t_1	40	40	40	ns min	$\overline{\text{CONVST}}$ Pulse Width
t_2	40 ²	40 ²	45 ²	ns min	SCLK High Pulse Width
t_3	40 ²	40 ²	45 ²	ns min	SCLK Low Pulse Width
t_4	60 ³ 100 ³	60 ³ 100 ³	70 ³ 110 ³	ns max ns max	Data Access Time After Falling Edge of SCLK $V_{DD} = 5\text{ V} \pm 10\%$ $V_{DD} = 2.7\text{ V to }+3.6\text{ V}$
t_5	10	10	10	ns min	Data Hold Time After Falling Edge of SCLK
t_6	50 ⁴	50 ⁴	50 ⁴	ns max	Bus Relinquish Time After Falling Edge of SCLK

NOTES

¹Sample tested at +25°C to ensure compliance. All input signals are measured with $t_r = t_f = 1\text{ ns}$ (10% to 90% of V_{DD}) and timed from a voltage level of +1.4 V.

²The SCLK maximum frequency is 10 MHz. Care must be taken when interfacing to account for the data access time, t_4 , and the setup time required for the user's processor. These two times will determine the maximum SCLK frequency that the user's system can operate with. See Serial Interface section for more information.

³Measured with the load circuit of Figure 1 and defined as the time required for an output to cross 0.8 V or 2.0 V.

⁴Derived from the measured time taken by the data outputs to change 0.5 V when loaded with the circuit of Figure 1. The measured number is then extrapolated back to remove the effects of charging or discharging the 50 pF capacitor. This means that the time, t_6 , quoted in the timing characteristics is the true bus relinquish time of the part and as such is independent of external bus loading capacitances.

ABSOLUTE MAXIMUM RATINGS*

($T_A = +25^\circ\text{C}$ unless otherwise noted)

V_{DD} to AGND	-0.3 V to +7 V
V_{DD} to DGND	-0.3 V to +7 V
Analog Input Voltage to AGND	-0.3 V to $V_{DD} + 0.3\text{ V}$
Digital Input Voltage to DGND	-0.3 V to $V_{DD} + 0.3\text{ V}$
Digital Output Voltage to DGND	-0.3 V to $V_{DD} + 0.3\text{ V}$
Operating Temperature Range		
Commercial (J Version)	0°C to +70°C
Industrial (A, B Versions)	-40°C to +85°C
Extended (S Version)	-55°C to +125°C
Storage Temperature Range	-65°C to +150°C
Junction Temperature	+150°C
Plastic DIP Package, Power Dissipation	450 mW
θ_{JA} Thermal Impedance	125°C/W
θ_{JC} Thermal Impedance	50°C/W
Lead Temperature (Soldering, 10 sec)	+260°C
SOIC Package, Power Dissipation	450 mW
θ_{JA} Thermal Impedance	160°C/W
θ_{JC} Thermal Impedance	75°C/W
Lead Temperature, Soldering		
Vapor Phase (60 sec)	+215°C
Infrared (15 sec)	+220°C
ESD	>4000 V

*Stresses above those listed under "Absolute Maximum Ratings" may cause permanent damage to the device. This is a stress rating only and functional operation of the device at these or any other conditions above those listed in the operational sections of this specification is not implied. Exposure to absolute maximum rating conditions for extended periods may affect device reliability.

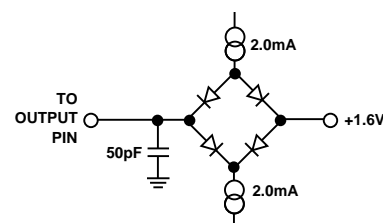

Figure 1. Load Circuit for Access Time and Bus Relinquish Time

AD7896

PIN FUNCTION DESCRIPTION

Pin No.	Pin Mnemonic	Description
1	V_{IN}	Analog Input. The analog input range is 0 V to V_{DD} .
2	V_{DD}	Positive supply voltage, +2.7 V to 5.5 V.
3	AGND	Analog Ground. Ground reference for track/hold, comparator and DAC.
4	SCLK	Serial Clock Input. An external serial clock is applied to this input to obtain serial data from the AD7896. A new serial data bit is clocked out on the falling edge of this serial clock. Data is guaranteed valid for 10 ns after this falling edge so data can be accepted on the falling edge when a fast serial clock is used. The serial clock input should be taken low at the end of the serial data transmission.
5	SDATA	Serial Data Output. Serial data from the AD7896 is provided at this output. The serial data is clocked out by the falling edge of SCLK, but the data can also be read on the falling edge of the SCLK. This is possible because data bit N is valid for a specified time after the falling edge of the SCLK (data hold time) and can be read before data bit N+1 becomes valid a specified time after the falling edge of SCLK (data access time) (see Figure 4). Sixteen bits of serial data are provided with four leading zeros followed by the 12 bits of conversion data. On the sixteenth falling edge of SCLK, the SDATA line is held for the data hold time and then disabled (three-stated). Output data coding is straight binary.
6	DGND	Digital Ground. Ground reference for digital circuitry.
7	\overline{CONVST}	Convert Start. Edge-triggered logic input. On the falling edge of this input, the track/hold goes into its hold mode and conversion is initiated. If \overline{CONVST} is low at the end of conversion, the part goes into power down mode. In this case, the rising edge of \overline{CONVST} “wakes up” the part.
8	BUSY	The BUSY pin is used to indicate when the part is doing a conversion. The BUSY pin will go high on the falling edge of \overline{CONVST} and will return low when the conversion is complete.

PIN CONFIGURATION

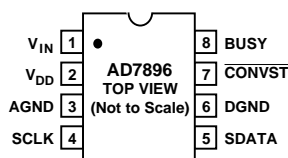

ORDERING GUIDE

Model	Temperature Range	Linearity Error (LSB)	SNR (dB)	Package Option*
AD7896AN	-40°C to +85°C	±1 LSB	70 dB	N-8
AD7896BN	-40°C to +85°C	±1/2 LSB	70 dB	N-8
AD7896AR	-40°C to +85°C	±1 LSB	70 dB	SO-8
AD7896BR	-40°C to +85°C	±1/2 LSB	70 dB	SO-8
AD7896JR	0°C to +70°C	±1 LSB	70 dB	SO-8
AD7896SQ	-55°C to +125°C	±1 LSB	70 dB	Q-8

*N = Plastic DIP; Q = Cerdip; SO = SOIC.

TERMINOLOGY**Relative Accuracy**

This is the maximum deviation from a straight line passing through the endpoints of the ADC transfer function. The endpoints of the transfer function are zero scale (*which is* $V_{IN} = AGND + 1/2 \text{ LSB}$) a point 1/2 LSB below the first code transition (00 . . . 000 to 00 . . . 001) and full scale (*which is* $V_{IN} = AGND + V_{DD} - 1/2 \text{ LSB}$), a point 1/2 LSB above the last code transition (11 . . . 110 to 11 . . . 111).

Differential Nonlinearity

This is the difference between the measured and the ideal 1 LSB change between any two adjacent codes in the ADC.

Unipolar Offset Error

This is the deviation of the first code transition (00 . . . 000 to 00 . . . 001) from the ideal V_{IN} voltage ($AGND + 1 \text{ LSB}$).

Positive Full-Scale Error

This is the deviation of the last code transition (11 . . . 110 to 11 . . . 111) from the ideal ($V_{IN} = AGND + V_{DD} - 1 \text{ LSB}$) after the offset error has been adjusted out.

Track/Hold Acquisition Time

Track/hold acquisition time is the time required for the output of the track/hold amplifier to reach its final value, within $\pm 1/2 \text{ LSB}$, after the end of conversion (*the point at which the track/hold returns into track mode*). It also applies to a situation where there is a step input change on the input voltage applied to the selected V_{IN} input of the AD7896. It means that the user must wait for the duration of the track/hold acquisition time after the end of conversion or after a step input change to V_{IN} before starting another conversion, to ensure the part operates to specification.

Signal to (Noise + Distortion) Ratio

This is the measured ratio of signal to (noise + distortion) at the output of the A/D converter. The signal is the rms amplitude of the fundamental. Noise is the sum of all nonfundamental signals up to half the sampling frequency ($f_s/2$), excluding dc. The ratio is dependent on the number of quantization levels in the digitization process; the more levels, the smaller the quantization noise. The theoretical signal to (noise + distortion) ratio for an ideal N-bit converter with a sine wave input is given by:

$$\text{Signal to (Noise + Distortion)} = (6.02N + 1.76) \text{ dB}$$

Thus for a 12-bit converter, this is 74 dB.

Total Harmonic Distortion

Total harmonic distortion (THD) is the ratio of the rms sum of harmonics to the fundamental. For the AD7896, it is defined as:

$$\text{THD (dB)} = 20 \log \frac{\sqrt{V_2^2 + V_3^2 + V_4^2 + V_5^2 + V_6^2}}{V_1}$$

where V_1 is the rms amplitude of the fundamental and V_2, V_3, V_4, V_5 and V_6 are the rms amplitudes of the second through the sixth harmonics.

Peak Harmonic or Spurious Noise

Peak harmonic or spurious noise is defined as the ratio of the rms value of the next largest component in the ADC output spectrum (up to $f_s/2$ and excluding dc) to the rms value of the fundamental. Normally, the value of this specification is determined by the largest harmonic in the spectrum, but for parts where the harmonics are buried in the noise floor, it will be a noise peak.

Intermodulation Distortion

With inputs consisting of sine waves at two frequencies, f_a and f_b , any active device with nonlinearities will create distortion products at sum and difference frequencies of $m f_a \pm n f_b$ where $m, n = 0, 1, 2, 3$, etc. Intermodulation distortion terms are those for which neither m nor n are equal to zero. For example, the second order terms include $(f_a + f_b)$ and $(f_a - f_b)$, while the third order terms include $(2f_a + f_b)$, $(2f_a - f_b)$, $(f_a + 2f_b)$ and $(f_a - 2f_b)$.

The AD7896 is tested using the CCIF standard where two input frequencies near the top end of the input bandwidth are used. In this case, the second order terms are usually distanced in frequency from the original sine waves while the third order terms are usually at a frequency close to the input frequencies. As a result, the second and third order terms are specified separately. The calculation of the intermodulation distortion is as per the THD specification where it is the ratio of the rms sum of the individual distortion products to the rms amplitude of the fundamental expressed in dBs.

AD7896

CONVERTER DETAILS

The AD7896 is a fast, 12-bit A/D converter that operates from a single +2.7 V to +5.5 V supply. It provides the user with a track/hold, A/D converter and serial interface logic functions on a single chip. The A/D converter section of the AD7896 consists of a conventional successive-approximation converter based around an R-2R ladder structure. The internal reference for the AD7896 is derived from V_{DD} , and this allows the part to accept an analog input range of 0 V to V_{DD} . The AD7896 has two operating modes, the high sampling mode and the auto sleep mode where the part automatically goes into sleep after the end of conversion. These modes are discussed in more detail in the Timing and Control section.

A major advantage of the AD7896 is that it provides all of the above functions in an 8-pin package, either 8-pin mini-DIP or SOIC. This offers the user considerable space saving advantages over alternative solutions. The AD7896 consumes only 9 mW typical making it ideal for battery-powered applications.

Conversion is initiated on the AD7896 by pulsing the $\overline{\text{CONVST}}$ input. On the falling edge of $\overline{\text{CONVST}}$, the on-chip track/hold goes from track to hold mode and the conversion sequence is started. The conversion clock for the part is generated internally using a laser-trimmed clock oscillator circuit. Conversion time for the AD7896 is 8 μs in the high sampling mode (14 μs for the auto sleep mode), and the track/hold acquisition time is 1.5 μs . To obtain optimum performance from the part, the read operation should not occur during the conversion or during 400 ns prior to the next conversion. This allows the part to operate at throughput rates up to 100 kHz and achieve data sheet specifications (see Timing and Control Section).

CIRCUIT DESCRIPTION

Analog Input Section

The analog input range for the AD7896 is 0 V to V_{DD} . The V_{IN} pin drives the input to the track/hold amplifier directly. This allows for a maximum output impedance of the circuit driving the analog input of 1 k Ω . This ensures that the part will be settled to 12-bit accuracy in the 1.5 μs acquisition time. This input is benign with dynamic charging currents. The designed code transitions occur on successive integer LSB values (i.e., 1 LSB, 2 LSB, 3 LSB . . . FS-1 LSB). Output coding is straight (natural) binary with 1 LSB = FS/4096 = 3.3 V/4096 = 0.81 mV. The ideal input/output transfer function is shown in Table I.

Table I. Ideal Input/Output Code Table for the AD7896

Analog Input ¹	Code Transition
+FSR - 1 LSB ² (3.299194)	111 . . . 110 to 111 . . . 111
+FSR - 2 LSB (3.298389)	111 . . . 101 to 111 . . . 110
+FSR/2 - 3 LSB (3.297583)	111 . . . 100 to 111 . . . 101
AGND + 3 LSB (0.002417)	000 . . . 010 to 000 . . . 011
AGND + 2 LSB (0.001611)	000 . . . 001 to 000 . . . 010
AGND + 1 LSB (0.000806)	000 . . . 000 to 000 . . . 001

NOTES

¹FSR is full-scale range and is 3.3 V with $V_{DD} = +3.3$ V.

²1 LSB = FSR/4096 = 0.81 mV with $V_{DD} = +3.3$ V.

Track/Hold Section

The track/hold amplifier on the analog input of the AD7896 allows the ADC to accurately convert an input sine wave of full-scale amplitude to 12-bit accuracy. The input bandwidth of the

track/hold is greater than the Nyquist rate of the ADC even when the ADC is operated at its maximum throughput rate of 100 kHz (i.e., the track/hold can handle input frequencies in excess of 50 kHz).

The track/hold amplifier acquires an input signal to 12-bit accuracy in less than 1.5 μs . The operation of the track/hold is essentially transparent to the user. With the high sampling operating mode the track/hold amplifier goes from its tracking mode to its hold mode at the start of conversion (i.e., the rising edge of $\overline{\text{CONVST}}$). The aperture time for the track/hold (i.e., the delay time between the external $\overline{\text{CONVST}}$ signal and the track/hold actually going into hold) is typically 15 ns. At the end of conversion (on the falling edge of $\overline{\text{CONVST}}$) the part returns to its tracking mode. The acquisition time of the track/hold amplifier begins at this point. For the auto shutdown mode, the rising edge of $\overline{\text{CONVST}}$ wakes up the part and the track and hold amplifier goes from its tracking mode to its hold mode 6 μs after the rising edge of $\overline{\text{CONVST}}$ (provided that the $\overline{\text{CONVST}}$ high time is less than 6 μs). Once again the part returns to its tracking mode at the end of conversion when the $\overline{\text{CONVST}}$ signal goes low.

Timing and Control Section

Figure 2 shows the timing and control sequence required to obtain optimum performance from the AD7896. In the sequence shown, conversion is initiated on the falling edge of $\overline{\text{CONVST}}$ and new data from this conversion is available in the output register of the AD7896 8 μs later. Once the read operation has taken place, a further 400 ns should be allowed before the next falling edge of $\overline{\text{CONVST}}$ to optimize the settling of the track/hold amplifier before the next conversion is initiated. With the serial clock frequency at its maximum of 10 MHz (5 V operation), the achievable throughput rate for the part is 8 μs (conversion time) plus 1.6 μs (read time) plus 0.4 μs (acquisition time). This results in a minimum throughput time of 10 μs (equivalent to a throughput rate of 100 kHz). A serial clock of less than 10 MHz can be used but this will in turn mean that the throughput time will increase.

The read operation consists of sixteen serial clock pulses to the output shift register of the AD7896. After sixteen serial clock pulses the shift register is reset and the $\overline{\text{SDATA}}$ line is three-stated. If there are more serial clock pulses after the sixteenth clock, the shift register will be moved on past its reset state. However, the shift register will be reset again on the falling edge of the $\overline{\text{CONVST}}$ signal to ensure that the part returns to a known state every conversion cycle. As a result, a read operation from the output register should not straddle across the falling edge of $\overline{\text{CONVST}}$ as the output shift register will be reset in the middle of the read operation and the data read back into the microprocessor will appear invalid.

The throughput rate of the part can be increased by reading data during conversion. If the data is read during conversion, a throughput time of 8 μs (conversion time) plus 1.5 μs (acquisition time) is achieved when a 10 MHz (5 V operation) serial clock is being used. This minimum throughput time of 9.5 μs is achieved with a slight reduction in performance from the AD7896. The advantage of this arrangement is that when the serial clock is significantly lower than 10 MHz the throughput time for this arrangement will be significantly less than the throughput time where the data is read after conversion. The Signal to (Noise + Distortion) number is likely to degrade by less than 1 dB while the code flicker from the part will also increase (see AD7896 PERFORMANCE section).

OPERATING MODES

Mode 1 Operation (High Sampling Performance)

The timing diagram in Figure 2 is for optimum performance in Operating Mode 1 where the falling edge of $\overline{\text{CONVST}}$ starts conversion and puts the Track/Hold amplifier into its hold mode. This falling edge of $\overline{\text{CONVST}}$ also causes the BUSY signal to go high to indicate that a conversion is taking place. The BUSY signal goes low when the conversion is complete which is 8 μs max after the falling edge of $\overline{\text{CONVST}}$, and new data from this conversion is available in the output register of the AD7896.

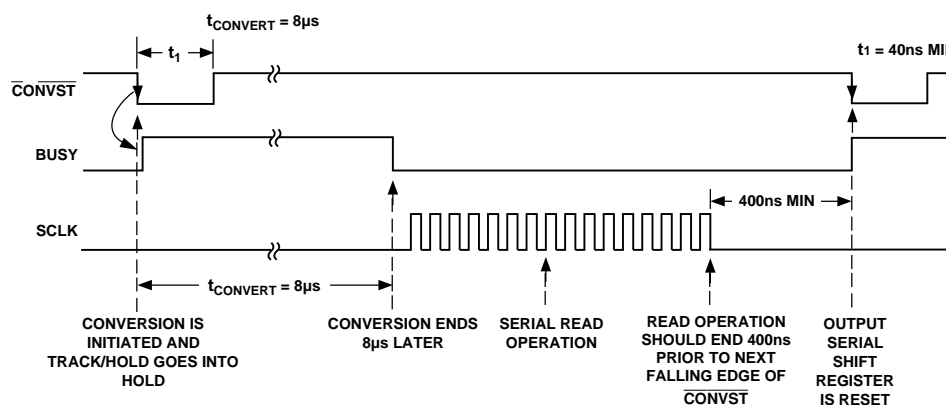

Figure 2. Mode 1 Timing Operation Diagram for High Sampling Performance

Mode 2 Operation (Auto Sleep After Conversion)

The timing diagram in Figure 3 is for optimum performance in Operating Mode 2 where the part automatically goes into sleep mode once BUSY goes low after conversion and “wakes up” before the next conversion takes place. This is achieved by keeping $\overline{\text{CONVST}}$ low at the end of conversion whereas it was high at the end of conversion for Mode 1 operation. The rising edge of $\overline{\text{CONVST}}$ “wakes up” the part. This wake-up time is 6 μs at which point the Track/Hold amplifier goes into its hold mode. The conversion takes 8 μs after this, provided the $\overline{\text{CONVST}}$ has gone low, giving a total of 14 μs from the rising edge of $\overline{\text{CONVST}}$ to the conversion being complete which is indicated by the BUSY going low. Note that since the wake-up time from the rising edge of $\overline{\text{CONVST}}$ is 6 μs , when the $\overline{\text{CONVST}}$ pulse width is greater than 6 μs the conversion will take more than the

A read operation accesses this data. This read operation consists of 16 clock cycles, and the length of this read operation will depend on the serial clock frequency. For the fastest throughput rate (with a serial clock of 10 MHz 5 V operation) the read operation will take 1.6 μs . The read operation must be complete at least 400 ns before the falling edge of the next $\overline{\text{CONVST}}$, and this gives a total time of 10 μs for the full throughput time (equivalent to 100 kHz). This mode of operation should be used for high sampling applications.

14 μs shown in diagram from the rising edge of $\overline{\text{CONVST}}$. This is because the Track/Hold amplifier goes into its hold mode on the falling edge of $\overline{\text{CONVST}}$ and then the conversion will not be complete for a further 8 μs . In this case the BUSY will be the best indicator for when the conversion is complete. Even though the part is in sleep mode, data can still be read from the part. The read operation consists of 16 clock cycles as in Mode 1 operation. For the fastest serial clock of 10 MHz 5 V operation the read operation will take 1.6 μs , and this must be complete at least 400 ns before the falling edge of the next $\overline{\text{CONVST}}$ to allow the Track/Hold amplifier to have enough time to settle. This mode is very useful when the part is converting at a slow rate as the power consumption will be significantly reduced from that of Mode 1 operation.

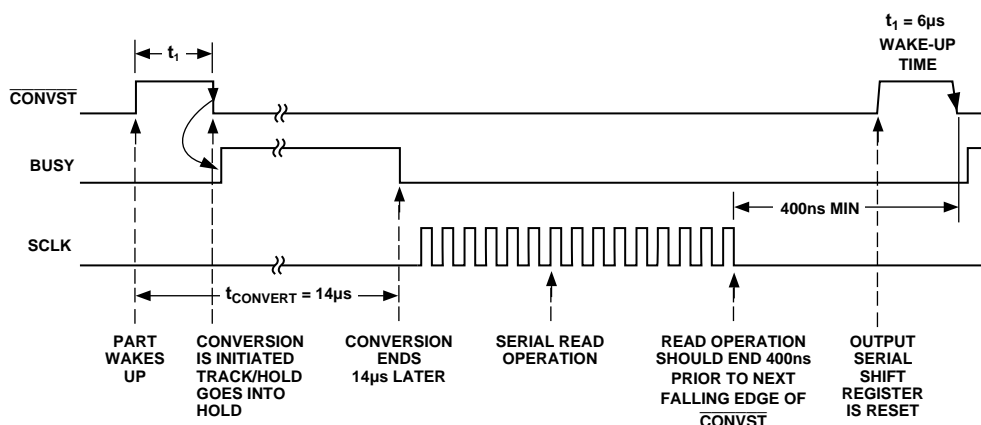

Figure 3. Mode 2 Timing Diagram Where Automatic Sleep Function Is Initiated

AD7896

Serial Interface

The serial interface to the AD7896 consists of just three wires, a serial clock input (SCLK) and the serial data output (SDATA) and a conversion status output (BUSY). This allows for an easy-to-use interface to most microcontrollers, DSP processors and shift registers.

Figure 4 shows the timing diagram for the read operation to the AD7896. The serial clock input (SCLK) provides the clock source for the serial interface. Serial data is clocked out from the SDATA line on the falling edge of this clock and is valid on both the rising and falling edges of SCLK. The advantage of having the data valid on both the rising and falling edges of the SCLK is so that it gives the user greater flexibility in interfacing to the part and also so that a wider range of microprocessor and microcontroller interfaces can be accommodated. This also explains the two timing figures t_4 and t_5 that are quoted on the diagram. The time t_4 specifies how long after the falling edge of the SCLK that the next data bit becomes valid whereas the time t_5 specifies how long after the falling edge of the SCLK that the current data bit is valid for. The first leading zero is clocked out on the first rising edge of SCLK, and note that the first zero may be valid on the first falling edge of SCLK even though the data access time is specified at 60 ns (5 V, A, B, J Versions only) for the other bits (and the SCLK high time will be 50 ns with a 10 MHz SCLK). The reason that the first bit will be clocked out faster than the other bits is due to the internal architecture of the part. Sixteen clock pulses must be provided to the part to access to full conversion result. The AD7896 provides four leading zeros followed by the 12-bit conversion result starting with the MSB (DB11). The last data bit to be clocked out on the penultimate falling clock edge is the LSB (DB0). On the sixteenth falling edge of SCLK the LSB (DB0) will be valid for a specified time to allow the bit to be read on the falling edge of the SCLK, and then the SDATA line is disabled (three-stated). After this last bit has been clocked out, the SCLK input should remain low until the next serial data read operation. If there are extra clock pulses after the sixteenth clock, the AD7896 will start over again with outputting data from its output register, and the data bus will no longer be three-stated even when the clock stops. Provided the serial clock has stopped before the next falling edge of $\overline{\text{CONVST}}$, the AD7896 will continue to operate correctly with the output shift register being reset on the

falling edge of $\overline{\text{CONVST}}$. However, the SCLK line must be low when $\overline{\text{CONVST}}$ goes low in order to reset the output shift register correctly.

The serial clock input does not need to be continuous during the serial read operation. The sixteen bits of data (four leading zeros and 12-bit conversion result) can be read from the AD7896 in a number of bytes. However, the SCLK input must remain low between the two bytes.

The maximum SCLK frequency will be 10 MHz for 5 V operation (giving a throughput of 100 kHz) and at 2.7 V the maximum SCLK frequency will be less than 10 MHz to allow for the longer data access time, t_4 (60 ns @ 5 V, 100 ns @ 2.7 V (A, B, J Versions) 70 ns @ 5 V, (110 ns @ 2.7 V (S Version))). Note that at 3.0 V operation (A, B, J Versions) an SCLK of 10 MHz (throughput rate of 100 kHz) may be acceptable if the required processor setup time is 0 ns (this may be possible with an ASIC or FPGA). The data must be read in the next 10 ns which is specified as the data hold time, t_5 , after the SCLK edge.

The AD7896 counts the serial clock edges to know which bit from the output register should be placed on the SDATA output. To ensure that the part does not lose synchronization, the serial clock counter is reset on the falling edge of the $\overline{\text{CONVST}}$ input provided the SCLK line is low. The user should ensure that a falling edge on the $\overline{\text{CONVST}}$ input does not occur while a serial data read operation is in progress.

MICROPROCESSOR/MICROCONTROLLER INTERFACE

The AD7896 provides a three-wire serial interface that can be used for connection to the serial ports of DSP processors and microcontrollers. Figures 5 through 8 show the AD7896 interfaced to a number of different microcontrollers and DSP processors. The AD7896 accepts an external serial clock and as a result, in all interfaces shown here, the processor/controller is configured as the master, providing the serial clock, with the AD7896 configured as the slave in the system.

AD7896-8051 Interface

Figure 5 shows an interface between the AD7896 and the 8X51/L51 microcontroller. The 8X51/L51 is configured for its Mode 0 serial interface mode. The diagram shows the simplest form of the interface where the AD7896 is the only part connected to the serial port of the 8X51/L51 and, therefore, no decoding of the serial read operations is required.

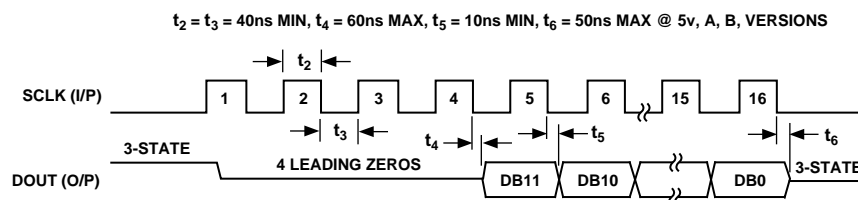

Figure 4. Data Read Operation

To chip select the AD7896 in systems where more than one device is connected to the 8X51/L51's serial port, a port bit, configured as an output, from one of the 8X51/L51's parallel ports can be used to gate on or off the serial clock to the AD7896. A simple AND function on this port bit and the serial clock from the 8X51/L51 will provide this function. The port bit should be high to select the AD7896 and low when it is not selected.

The end of conversion is monitored by using the BUSY signal which is shown in the interface diagram of Figure 5. With the BUSY line from the AD7896 connected to the Port P1.2 of the 8X51/L51 so the BUSY line can be polled by the 8X51/L51. The BUSY line can be connected to the INT1 line of the 8X51/L51 if an interrupt driven system is preferred. These two options are shown on the diagram.

Note also that the AD7896 outputs the MSB first during a read operation while the 8X51/L51 expects the LSB first. Therefore, the data which is read into the serial buffer needs to be rearranged before the correct data format from the AD7896 appears in the accumulator.

The serial clock rate from the 8X51/L51 is limited to significantly less than the allowable input serial clock frequency with which the AD7896 can operate. As a result, the time to read data from the part will actually be longer than the conversion time of the part. This means that the AD7896 cannot run at its maximum throughput rate when used with the 8X51/L51.

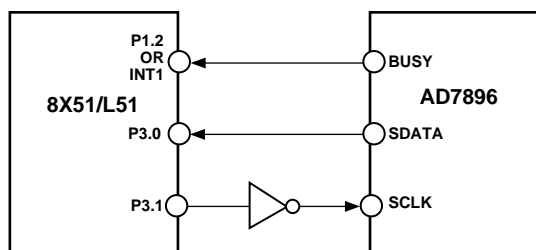

Figure 5. AD7896 to 8X51/L51 Interface

AD7896–68HC11/L11 Interface

An interface circuit between the AD7896 and the 68HC11/L11 microcontroller is shown in Figure 6. For the interface shown, the 68HC11/L11 SPI port is used and the 68HC11/L11 is configured in its single-chip mode. The 68HC11/L11 is configured in the master mode with its CPOL bit set to a logic zero and its CPHA bit set to a logic one. As with the previous interface, the diagram shows the simplest form of the interface where the AD7896 is the only part connected to the serial port of the 68HC11/L11 and, therefore, no decoding of the serial read operations is required.

Once again, to chip select the AD7896 in systems where more than one device is connected to the 68HC11/L11's serial port, a port bit, configured as an output, from one of the 68HC11/L11's parallel ports can be used to gate on or off the serial clock to the AD7896. A simple AND function on this port bit and the serial clock from the 68HC11/L11 will provide this function. The port bit should be high to select the AD7896 and low when it is not selected.

The end of conversion is monitored by using the BUSY signal which is shown in the interface diagram of Figure 6. With the BUSY line from the AD7896 connected to the Port PC0 of the 68HC11/L11 the BUSY line can be polled by the 68HC11/L11.

The BUSY line can be connected to the $\overline{\text{IRQ}}$ line of the 68HC11/L11 if an interrupt driven system is preferred. These two options are shown in the diagram.

The serial clock rate from the 68HC11/L11 is limited to significantly less than the allowable input serial clock frequency with which the AD7896 can operate. As a result, the time to read data from the part will actually be longer than the conversion time of the part. This means that the AD7896 cannot run at its maximum throughput rate when used with the 68HC11/L11.

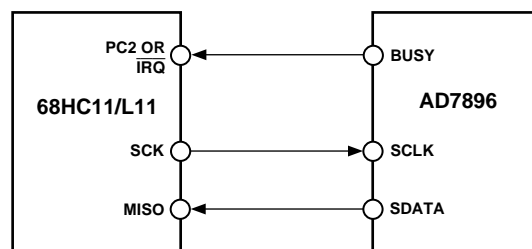

Figure 6. AD7896 to 68HC11/L11 Interface

AD7896–ADSP-2103/ADSP-2105 Interface

An interface circuit between the AD7896 and the ADSP-2103/ADSP-2105 DSP processor is shown in Figure 7. In the interface shown, the RFS1 output from the ADSP-2103/ADSP-2105's SPORT1 serial port is used to gate the serial clock (SCLK1) of the ADSP-2103/ADSP-2105 before it is applied to the SCLK input of the AD7896. The RFS1 output is configured for active high operation. The BUSY line from the AD7896 is connected to the IRQ2 line of the ADSP-2103/ADSP-2105 so that at the end of conversion an interrupt is generated telling the ADSP-2103/ADSP-2105 to initiate a read operation. The interface ensures a noncontinuous clock for the AD7896's serial clock input, with only sixteen serial clock pulses provided and the serial clock line of the AD7896 remaining low between data transfers. The SDATA line from the AD7896 is connected to the DR1 line of the ADSP-2103/ADSP-2105's serial port.

The timing relationship between the SCLK1 and RFS1 outputs of the ADSP-2103/ADSP-2105 are such that the delay between the rising edge of the SCLK1 and the rising edge of an active high RFS1 is up to 30 ns. There is also a requirement that data must be set up 10 ns prior to the falling edge of the SCLK1 to be read correctly by the ADSP-2103/ADSP-2105. The data access time for the AD7896 is 60 ns (5 V (A, B versions)) from the rising edge of its SCLK input. Assuming a 10 ns propagation delay through the external AND gate, the high time of the SCLK1 output of the ADSP-2105 must be $\geq (30 + 60 + 10 + 10)$ ns, i.e., ≥ 110 ns. This means that the serial clock frequency with which the interface of Figure 7 can work is limited to 4.5 MHz. However, there is an alternative method which allows for the ADSP-2105 SCLK1 to run at 5 MHz (which is the max serial clock frequency of the SCLK1 output). The arrangement is where the first leading zero of the data stream from the AD7896 cannot be guaranteed to be clocked into the ADSP-2105 due to the combined delay of the RFS signal and the data access time of the AD7896. In most cases this is acceptable as there will still be three leading zeros followed by the 12 data bits. For the ADSP-2103 the SCLK1 frequency will need to be limited to < 4 MHz to account for the 100 ns data access time of the AD7896 at 3 V.

AD7896

Another alternative scheme is to configure the ADSP-2103/ADSP-2105 such that it accepts an external noncontinuous serial clock. In this case, an external noncontinuous serial clock is provided which drives the serial clock inputs of both the ADSP-2103/ADSP-2105 and the AD7896. In this scheme, the serial clock frequency is limited to 10 MHz by the AD7896.

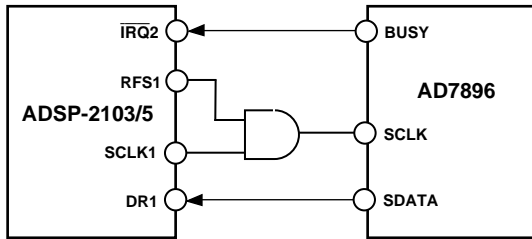

Figure 7. AD7896 to ADSP-2103 /5 Interface

AD7896–DSP56002/L002 Interface

Figure 8 shows an interface circuit between the AD7896 and the DSP56002/L002 DSP processor. The DSP56002/L002 is configured for normal mode asynchronous operation with gated clock. It is also set up for a 16-bit word with SCK as gated clock output. In this mode, the DSP56002/L002 provides sixteen serial clock pulses to the AD7896 in a serial read operation. The DSP56002/L002 assumes valid data on the first falling edge of SCK so the interface is simply two-wire as shown in Figure 8.

The $\overline{\text{BUSY}}$ line from the AD7896 is connected to the $\overline{\text{MODA}}/\overline{\text{IRQA}}$ input of the DSP56002/L002 so that an interrupt will be generated at the end of conversion. This ensures that the read operation will take place after conversion is finished.

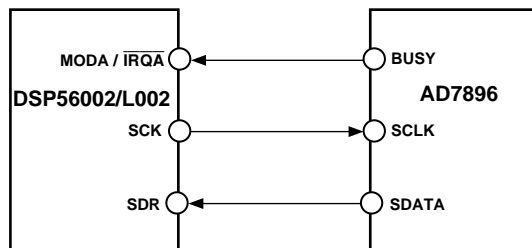

Figure 8. AD7896 to DSP56002/L002 Interface

AD7896 PERFORMANCE

Linearity

The linearity of the AD7896 is determined by the on-chip 12-bit D/A converter. This is a segmented DAC which is laser trimmed for 12-bit integral linearity and differential linearity. Typical relative accuracy numbers for the part are $\pm 1/4$ LSB while the typical DNL errors are $\pm 1/2$ LSB.

Noise

In an A/D converter, noise exhibits itself as code uncertainty in dc applications and as the noise floor (in an FFT, for example) in ac applications. In a sampling A/D converter like the AD7896, all information about the analog input appears in the baseband from dc to $1/2$ the sampling frequency. The input bandwidth of the track/hold exceeds the Nyquist bandwidth and, therefore, an antialiasing filter should be used to remove unwanted signals above $f_s/2$ in the input signal in applications where such signals exist.

Figure 9 shows a histogram plot for 8192 conversions of a dc input using the AD7896 with 3.3 V supply. The analog input was set at the center of a code transition. It can be seen that almost all the codes appear in the one output bin indicating very good noise performance from the ADC. The rms noise performance for the AD7896 for the plot below was 111 μV .

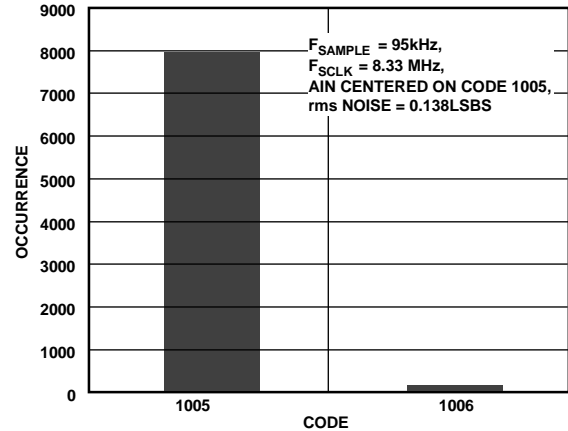

Figure 9. Histogram of 8192 Conversions of a DC Input

The same data is presented in Figure 10 as in Figure 9 except that in this case the output data read for the device occurs during conversion. This has the effect of injecting noise onto the die while bit decisions are being made and this increases the noise generated by the AD7896. The histogram plot for 8192 conversions of the same dc input now shows a larger spread of codes with the rms noise for the AD7896 increasing to 279 μV . This effect will vary depending on where the serial clock edges appear with respect to the bit trials of the conversion process. It is possible to achieve the same level of performance when reading during conversion as when reading after conversion depending on the relationship of the serial clock edges to the bit trial points.

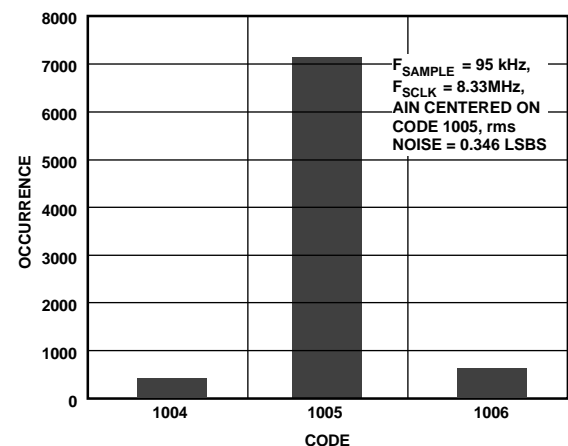

Figure 10. Histogram of 8192 Conversions with Read During Conversion

Dynamic Performance (Mode 1 Only)

With a combined conversion and acquisition time of 9.5 μ s, the AD7896 is ideal for wide bandwidth signal processing applications. These applications require information on the ADC's effect on the spectral content of the input signal. Signal to (Noise + Distortion), Total Harmonic Distortion, Peak Harmonic or Spurious Noise and Intermodulation Distortion are all specified. Figure 11 shows a typical FFT plot of a 10 kHz, 0 V to +3.3 V input after being digitized by the AD7896 operating at a 102.4 kHz sampling rate. The Signal to (Noise + Distortion) Ratio is 71.5 dB and the Total Harmonic Distortion is -83 dB.

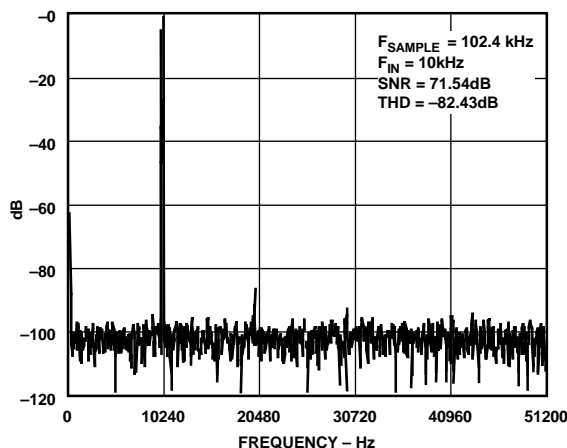

Figure 11. AD7896 FFT Plot

Effective Number of Bits

The formula for Signal to (Noise + Distortion) Ratio (See Terminology section) is related to the resolution or number of bits in the converter. Rewriting the formula, below, gives a measure of performance expressed in effective number of bits (N):

$$N = (\text{SNR} - 1.76) / 6.02$$

where SNR is Signal to (Noise + Distortion) Ratio.

The effective number of bits for a device can be calculated from its measured Signal to (Noise + Distortion) Ratio. Figure 12 shows a typical plot of effective number of bits versus frequency for the AD7896 from dc to $f_{\text{SAMPLING}}/2$. The sampling frequency is 102.4 kHz. The plot shows that the AD7896 converts an input sine wave of 51.2 kHz to an effective number of bits of 11.25 which equates to a Signal to (Noise + Distortion) level of 69 dB.

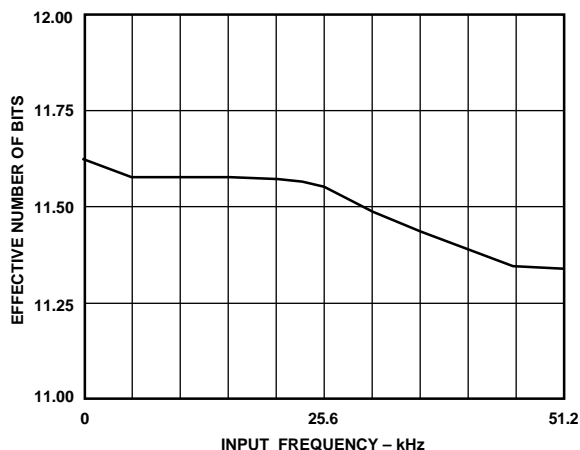

Figure 12. Effective Number of Bits vs. Frequency

Power Considerations

In the automatic power-down mode then the part may be operated at a sample rate which is considerably less than 100 kHz. In this case the power consumption will be reduced and will depend on the sample rate. Figure 13 shows a graph of the power consumption versus sampling rates from 10 Hz to 1 kHz in the automatic power-down mode. The conditions are 2.7 V supply 25°C, serial clock frequency of 8.33 MHz and the data was read after conversion.

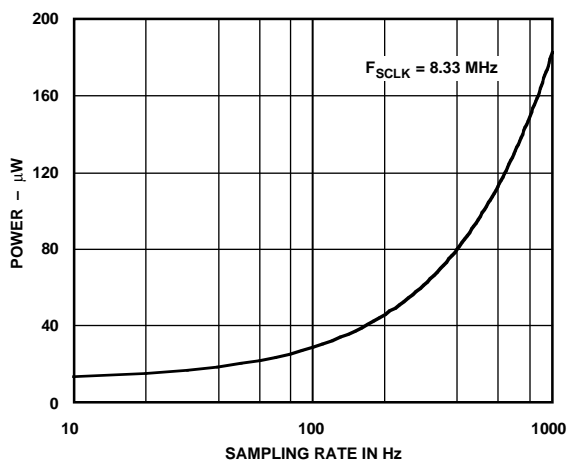
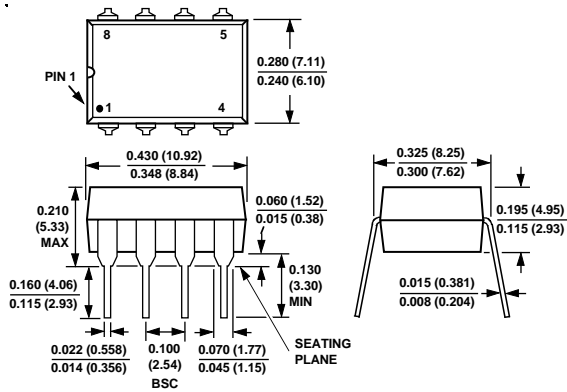

Figure 13. Power vs. Sample Rate in Auto Power-Down Mode

OUTLINE DIMENSIONS
 Dimensions shown in inches and (mm).

**8-Lead Plastic DIP
 (N-8)**



**8-Lead Cerdip
 (Q-8)**

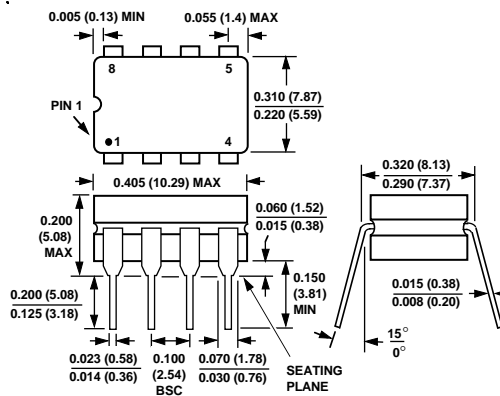

**8-Lead Small Outline
 (SO-8)**

