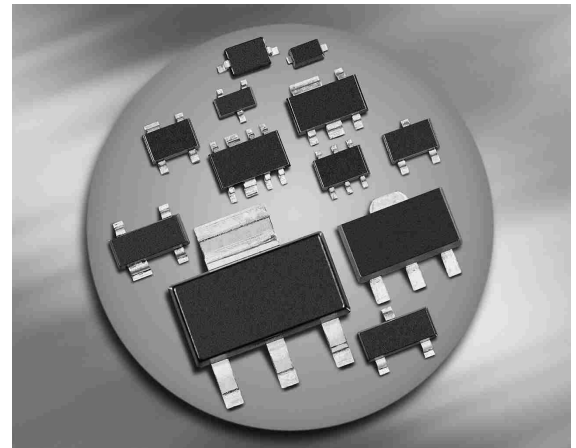
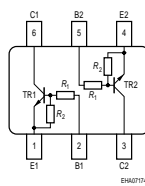
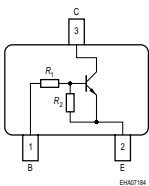

**NPN Silicon Digital Transistor**

- Switching circuit, inverter, interface circuit driver circuit
- Built in bias resistor ( $R_1=47\text{ k}\Omega$ ,  $R_2=47\text{ k}\Omega$ )
- BCR148S: Two internally isolated transistors with good matching in one multichip package
- BCR148S: For orientation in reel see package information below
- Pb-free (RoHS compliant) package <sup>1)</sup>
- Qualified according AEC Q101

**BCR148/F**  
**BCR148W**
**BCR148S**

Type	Marking	Pin Configuration						Package
		1=B	2=E	3=C	-	-	-	
BCR148	WEs	1=B	2=E	3=C	-	-	-	SOT23
BCR148F	WEs	1=B	2=E	3=C	-	-	-	TSFP-3
BCR148S	WEs	1=E1	2=B1	3=C2	4=E2	5=B2	6=C1	SOT363
BCR148W	WEs	1=B	2=E	3=C	-	-	-	SOT323

<sup>1</sup>Pb-containing package may be available upon special request

**Maximum Ratings**

Parameter	Symbol	Value	Unit
Collector-emitter voltage	$V_{CEO}$	50	V
Collector-base voltage	$V_{CBO}$	50	
Input forward voltage	$V_{i(fwd)}$	80	
Input reverse voltage	$V_{i(rev)}$	10	
Collector current	$I_C$	100	mA
Total power dissipation- BCR148, $T_S \leq 102^\circ\text{C}$ BCR148F, $T_S \leq 128^\circ\text{C}$ BCR148S, $T_S \leq 115^\circ\text{C}$ BCR148W, $T_S \leq 124^\circ\text{C}$	$P_{tot}$	200 250 250 250	mW
Junction temperature	$T_j$	150	°C
Storage temperature	$T_{stg}$	-65 ... 150	

**Thermal Resistance**

Parameter	Symbol	Value	Unit
Junction - soldering point <sup>1)</sup>	$R_{thJS}$		K/W
BCR148		$\leq 240$	
BCR148F		$\leq 90$	
BCR148S		$\leq 140$	
BCR148W		$\leq 105$	

<sup>1</sup>For calculation of  $R_{thJA}$  please refer to Application Note Thermal Resistance

**Electrical Characteristics at  $T_A = 25^\circ\text{C}$ , unless otherwise specified**

Parameter	Symbol	Values			Unit
		min.	typ.	max.	
<b>DC Characteristics</b>					
Collector-emitter breakdown voltage $I_C = 100 \mu\text{A}, I_B = 0$	$V_{(BR)CEO}$	50	-	-	V
Collector-base breakdown voltage $I_C = 10 \mu\text{A}, I_E = 0$	$V_{(BR)CBO}$	50	-	-	
Collector-base cutoff current $V_{CB} = 40 \text{ V}, I_E = 0$	$I_{CBO}$	-	-	100	nA
Emitter-base cutoff current $V_{EB} = 10 \text{ V}, I_C = 0$	$I_{EBO}$	-	-	164	$\mu\text{A}$
DC current gain <sup>1)</sup> $I_C = 5 \text{ mA}, V_{CE} = 5 \text{ V}$	$h_{FE}$	70	-	-	-
Collector-emitter saturation voltage <sup>1)</sup> $I_C = 10 \text{ mA}, I_B = 0.5 \text{ mA}$	$V_{CEsat}$	-	-	0.3	V
Input off voltage $I_C = 100 \mu\text{A}, V_{CE} = 5 \text{ V}$	$V_{i(off)}$	0.8	-	1.5	
Input on voltage $I_C = 2 \text{ mA}, V_{CE} = 0.3 \text{ V}$	$V_{i(on)}$	1	-	3	
Input resistor	$R_1$	32	47	62	$\text{k}\Omega$
Resistor ratio	$R_1/R_2$	0.9	1	1.1	-
<b>AC Characteristics</b>					
Transition frequency $I_C = 10 \text{ mA}, V_{CE} = 5 \text{ V}, f = 100 \text{ MHz}$	$f_T$	-	100	-	MHz
Collector-base capacitance $V_{CB} = 10 \text{ V}, f = 1 \text{ MHz}$	$C_{cb}$	-	3	-	pF

<sup>1</sup>Pulse test:  $t < 300 \mu\text{s}$ ;  $D < 2\%$

**DC current gain  $h_{FE} = f(I_C)$**

$V_{CE} = 5V$  (common emitter configuration)

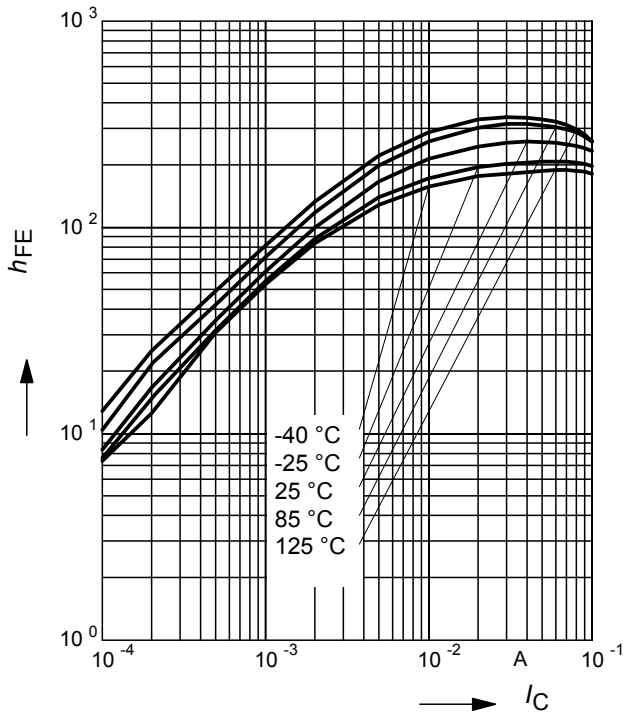

**Collector-emitter saturation voltage**

$V_{CEsat} = f(I_C), I_C/I_B = 20$

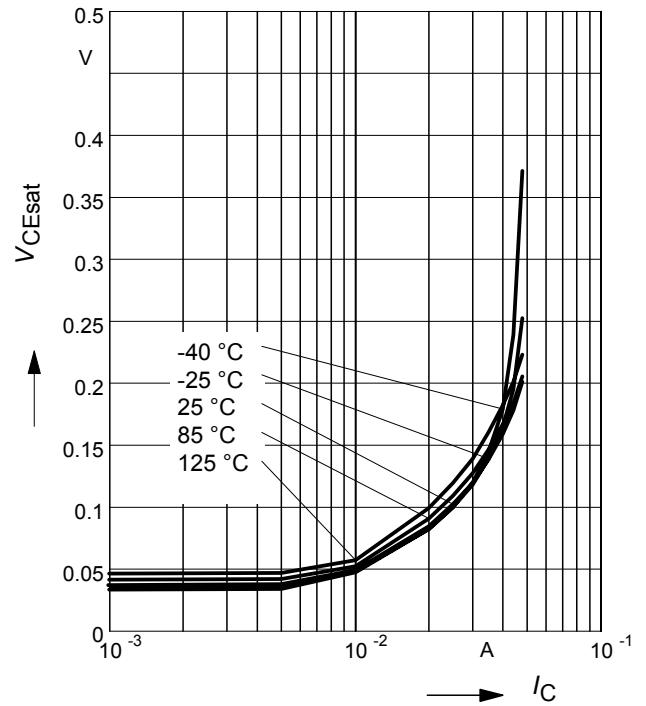

**Input on Voltage  $V_{i(on)} = f(I_C)$**

$V_{CE} = 0.3V$  (common emitter configuration)

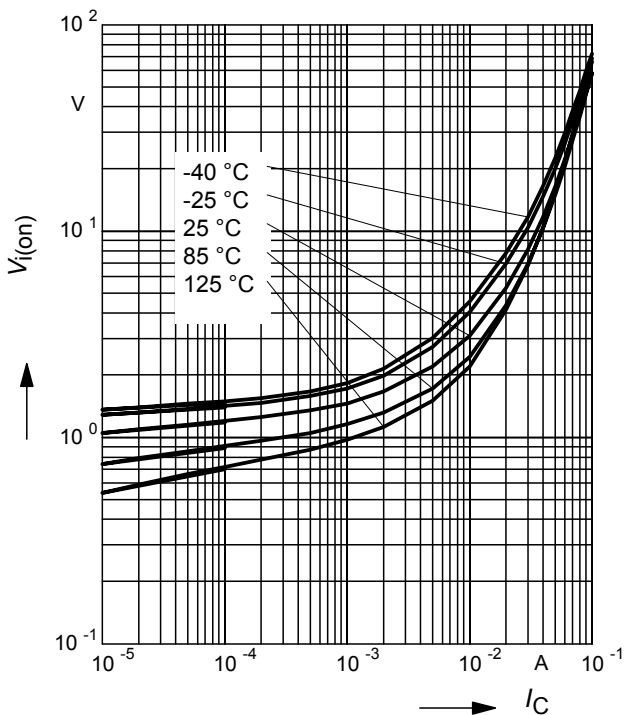

**Input off voltage  $V_{i(off)} = f(I_C)$**

$V_{CE} = 5V$  (common emitter configuration)

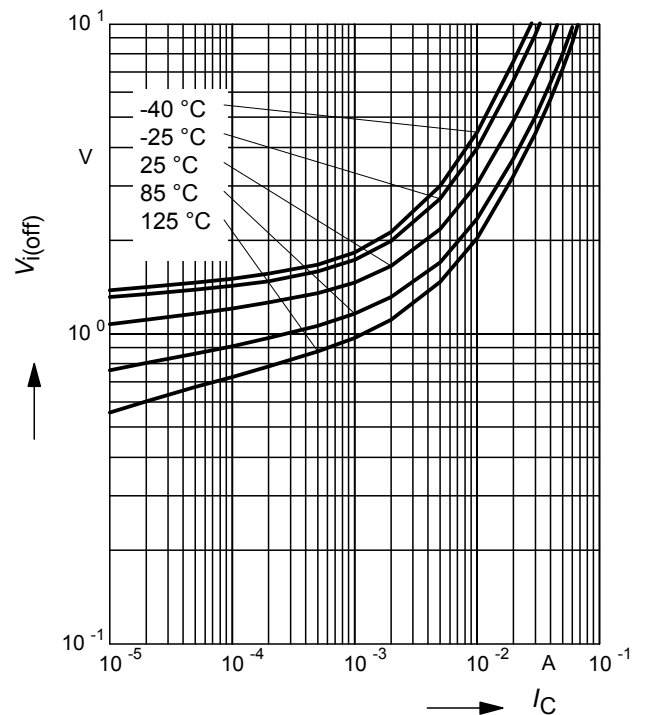

Total power dissipation  $P_{tot} = f(T_S)$

BCR148



Total power dissipation  $P_{tot} = f(T_S)$

BCR148F



Total power dissipation  $P_{tot} = f(T_S)$

BCR148S



Total power dissipation  $P_{tot} = f(T_S)$

BCR148W



**Permissible Pulse Load  $R_{thJS} = f(t_p)$**

BCR148



**Permissible Pulse Load**

$P_{totmax}/P_{totDC} = f(t_p)$

BCR148



**Permissible Puls Load  $R_{thJS} = f(t_p)$**

BCR148F



**Permissible Pulse Load**

$P_{totmax}/P_{totDC} = f(t_p)$

BCR148F



**Permissible Puls Load  $R_{thJS} = f(t_p)$**

BCR148S



**Permissible Pulse Load**

$P_{totmax}/P_{totDC} = f(t_p)$

BCR148S



**Permissible Puls Load  $R_{thJS} = f(t_p)$**

BCR148W

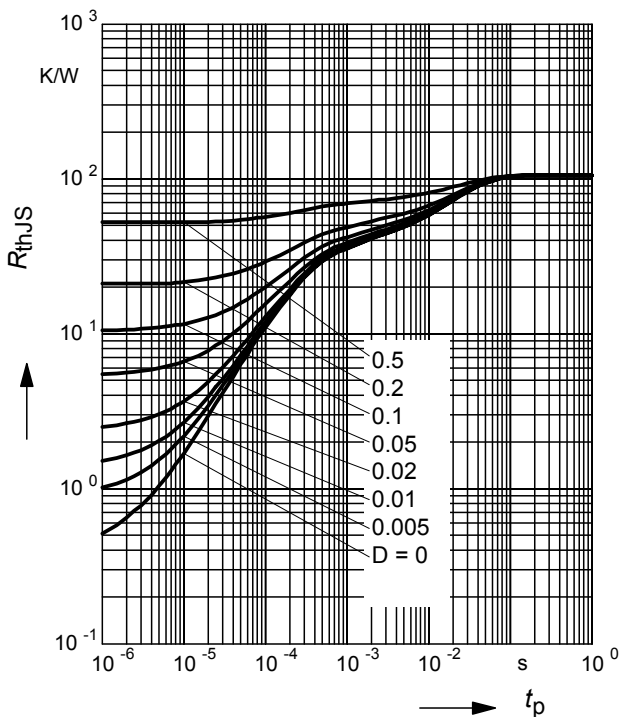

**Permissible Pulse Load**

$P_{totmax}/P_{totDC} = f(t_p)$

BCR148W



Package Outline



1) Lead width can be 0.6 max. in dambar area

Foot Print



Marking Layout (Example)



Standard Packing

Reel  $\varnothing$ 180 mm = 3.000 Pieces/Reel  
 Reel  $\varnothing$ 330 mm = 10.000 Pieces/Reel

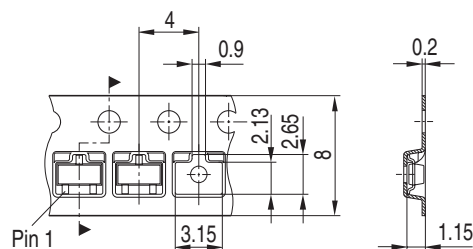



Package Outline



Foot Print

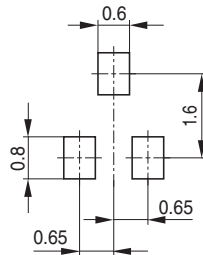

Marking Layout (Example)

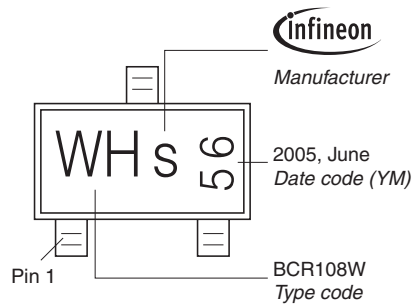

Standard Packing

Reel  $\varnothing$ 180 mm = 3.000 Pieces/Reel  
 Reel  $\varnothing$ 330 mm = 10.000 Pieces/Reel



Package Outline



Foot Print



Marking Layout (Example)

Small variations in positioning of Date code, Type code and Manufacture are possible.



Standard Packing

Reel ø180 mm = 3.000 Pieces/Reel  
 Reel ø330 mm = 10.000 Pieces/Reel

For symmetric types no defined Pin 1 orientation in reel.



Package Outline

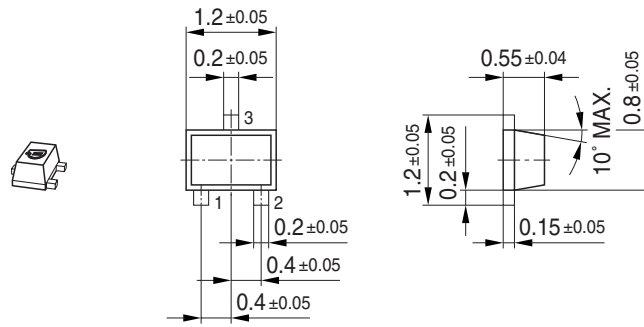

Foot Print

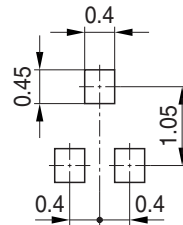

Marking Layout (Example)

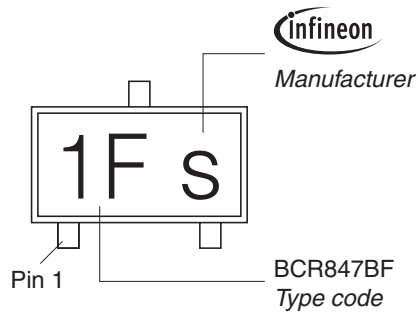

Standard Packing

Reel ø180 mm = 3.000 Pieces/Reel  
 Reel ø330 mm = 10.000 Pieces/Reel

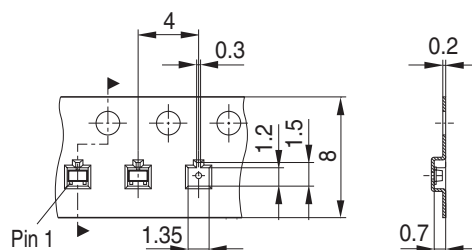

Edition 2006-02-01  
Published by  
Infineon Technologies AG  
81726 München, Germany  
© Infineon Technologies AG 2007.  
All Rights Reserved.

### **Attention please!**

The information given in this dokument shall in no event be regarded as a guarantee of conditions or characteristics ("Beschaffenheitsgarantie"). With respect to any examples or hints given herein, any typical values stated herein and/or any information regarding the application of the device, Infineon Technologies hereby disclaims any and all warranties and liabilities of any kind, including without limitation warranties of non-infringement of intellectual property rights of any third party.

### **Information**

For further information on technology, delivery terms and conditions and prices please contact your nearest Infineon Technologies Office ([www.infineon.com](http://www.infineon.com)).

### **Warnings**

Due to technical requirements components may contain dangerous substances. For information on the types in question please contact your nearest Infineon Technologies Office.

Infineon Technologies Components may only be used in life-support devices or systems with the express written approval of Infineon Technologies, if a failure of such components can reasonably be expected to cause the failure of that life-support device or system, or to affect the safety or effectiveness of that device or system.

Life support devices or systems are intended to be implanted in the human body, or to support and/or maintain and sustain and/or protect human life. If they fail, it is reasonable to assume that the health of the user or other persons may be endangered.