

6W isolated DC-DC converter in DIP package  
Ultra-wide input and regulated dual/single output

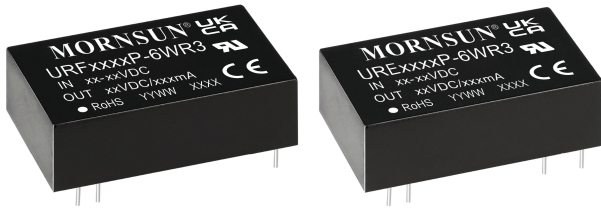

Patent Protection



UL60950-1



EN62368-1



BS EN62368-1



IEC60950-1

## FEATURES

- Ultra-wide 4:1 input voltage range
- High efficiency up to 88%
- No-load power consumption as low as 0.12W
- I/O isolation test voltage 3k VDC
- Operating ambient temperature range: -40°C to +85°C
- Input under-voltage protection, output short-circuit, over-voltage, over-current protection
- Meet CISPR32/EN55032 CLASS A, without extra components
- Industry standard pin-out

URE\_P-6WR3 & URF\_P-6WR3 series of isolated 6W DC-DC converter products with an ultra-wide 4:1 input voltage. They feature efficiencies of up to 88%, 3000VDC input to output isolation, operating ambient temperature of -40°C to +85°C, input under-voltage protection, output short-circuit, over-voltage, over-current protection. The products meet CLASS A of CISPR32/EN55032 EMI standards, they are widely used in applications such as industrial control, electrical power, instruments and telecommunication fields.

## Selection Guide

Certification	Part No.	Input Voltage (VDC)		Output		Full Load Efficiency <sup>②</sup> (%) Min./Typ.	Capacitive Load <sup>③</sup> (μF) Max.
		Nominal (Range)	Max. <sup>①</sup>	Voltage (VDC)	Current (mA) Max./Min.		
UL/EN/BS EN/IEC	URE2405P-6WR3	24 (9-36)	40	±5	±600/0	78/80	680
	URE2412P-6WR3			±12	±250/0	81/83	330
	URE2415P-6WR3			±15	±200/0	82/84	220
	URF2403P-6WR3			3.3	1500/0	75/77	2200
	URF2405P-6WR3			5	1200/0	79/81	2200
	URF2409P-6WR3			9	667/0	82/84	1000
	URF2412P-6WR3			12	500/0	82/84	680
	URF2415P-6WR3			15	400/0	84/86	680
	URF2424P-6WR3			24	250/0	84/86	680
	URF2425P-6WR3			25	240/0	83/85	680
UL/EN/BS EN/IEC	URF4803P-6WR3	48 (18-75)	80	3.3	1500/0	77/79	2200
	URF4805P-6WR3			5	1200/0	81/83	2200
	URF4812P-6WR3			12	500/0	85/87	680
	URF4815P-6WR3			15	400/0	86/88	680
	URF4824P-6WR3			24	250/0	85/87	680

Notes:

- ① Exceeding the maximum input voltage may cause permanent damage;
- ② Efficiency is measured at nominal input voltage and rated output load;
- ③ The specified maximum capacitive load for positive and negative output is identical.

## Input Specifications

Item	Operating Conditions		Min.	Typ.	Max.	Unit
Input Current (full load / no-load)	24VDC Input	3.3V output	--	320/10	329/16	mA
		Others	--	298/10	320/16	
	48VDC Input	3.3V output	--	158/4	162/7	
		Others	--	147/4	154/7	
Reflected Ripple Current	24VDC Input		--	20	--	
	48VDC Input		--	20	--	
Surge Voltage (1sec. max.)	24VDC Input		-0.7	--	50	VDC
	48VDC Input		-0.7	--	100	

Start-up Voltage	24VDC Input	--	--	9	VDC
	48VDC Input	--	--	18	
Input Under-voltage Protection	24VDC Input	5.5	6.5	--	
	48VDC Input	12	15.5	--	
Start-up Time	Nominal input& constant resistance load	--	10	--	ms
Input Filter		Pi filter			
Hot Plug		Unavailable			

### Output Specifications

Item	Operating Conditions	Min.	Typ.	Max.	Unit	
Voltage Accuracy	5%-100% load	--	±1	±3	%	
	0%-5% load	Single output	--	±1		±3
		Dual output	--	±2		±5
Balance of Output Voltage	Dual output, balanced load	--	±0.5	±1.5		
Linear Regulation	Input voltage variation from low to high at full load	Vo1	--	±0.2		±0.5
		Vo2	--	±0.5		±1
Load Regulation <sup>①</sup>	5%-100% load	Vo1	--	±0.5	±1	
		Vo2	--	±0.5	±1.5	
Cross Regulation	Dual output, Vo1 load at 50%, Vo2 load at range of 10%-100%	--	--	±5		
Transient Recovery Time	25% load step change	--	300	500	μs	
Transient Response Deviation		--	±3	±5	%	
Temperature Coefficient	Full load	--	--	±0.03	%/°C	
Ripple&Noise <sup>②</sup>	20MHz bandwidth, 5%-100% load	--	85	120	mVp-p	
Over-voltage Protection	Input voltage range	110	--	160	%Vo	
Over-current Protection	Input voltage range	24V output	110	220	290	%Io
		Others	110	140	190	
Short-circuit Protection	Input voltage range	Continuous, self-recovery				

Note:①Load regulation for 0%-100% load is ±5%;  
②Under 0% -5% load conditions, ripple & noise does not exceed 5%Vo. The "parallel cable" method is used for ripple and noise test, please refer to DC-DC Converter Application Notes for specific information.

### General Specifications

Item	Operating Conditions	Min.	Typ.	Max.	Unit
Isolation	Input-output Electric Strength test for 1 minute with a leakage current of 1mA max.	3000	--	--	VDC
Isolation Resistance	Input-output resistance at 500VDC	1000	--	--	MΩ
Isolation Capacitance	Input-output capacitance at 100kHz/0.1V	--	1000	--	pF
Operating Temperature	Derating when operating temperature up to 71°C (see Fig. 1)	-40	--	85	°C
Storage Temperature		-55	--	125	
Storage Humidity	Non-condensing	5	--	95	%RH
Pin Soldering Resistance Temperature	Soldering spot is 1.5mm away from case for 10 seconds	--	--	300	°C
Vibration		10-55Hz, 2G, 30 Min. along X, Y and Z			
Switching Frequency	PWM mode	--	300	--	kHz
MTBF	MIL-HDBK-217F@25°C	1000	--	--	k hours

Note:\*Switching frequency is measured at full load. The module reduces the switching frequency for light load (below 50%) efficiency improvement.

### Mechanical Specifications

Case Material	Black plastic; flame-retardant and heat-resistant (UL94-V0)
Dimensions	31.60 x 20.30 x 10.20 mm
Weight	13g(Typ.)
Cooling method	Free air convection

Electromagnetic Compatibility (EMC)

Emissions	CE	CISPR32/EN55032	CLASS A (without extra components)/ CLASS B (see Fig.3-② for recommended circuit)	
	RE	CISPR32/EN55032	CLASS A (without extra components)/ CLASS B (see Fig.3-② for recommended circuit)	
Immunity	ESD	IEC/EN61000-4-2	Contact ±4kV	perf. Criteria B
	RS	IEC/EN61000-4-3	10V/m	perf. Criteria A
	EFT	IEC/EN61000-4-4	±2kV (see Fig.3-① for recommended circuit)	perf. Criteria B
	Surge	IEC/EN61000-4-5	±2kV (see Fig.3-① for recommended circuit)	perf. Criteria B
	CS	IEC/EN61000-4-6	3 Vr.m.s	perf. Criteria A
	Voltage dips, short interruptions and voltage variations immunity	IEC/EN61000-4-29	0-70%	perf. Criteria B

Typical Characteristic Curves

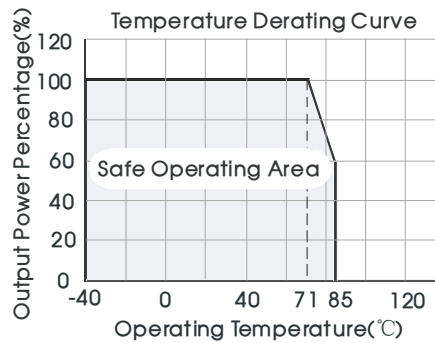
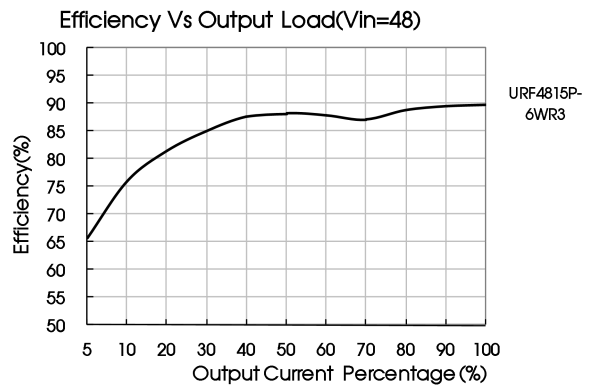
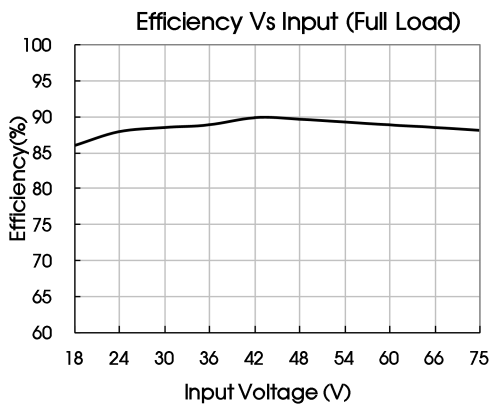
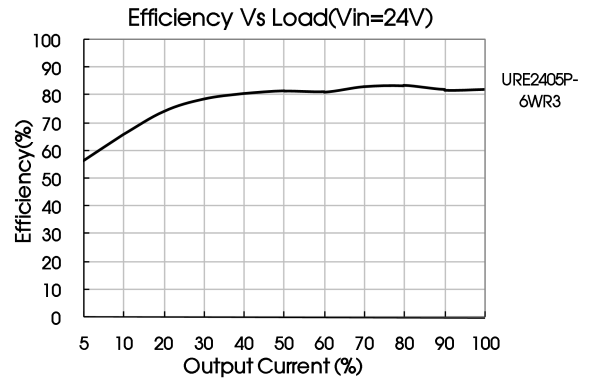
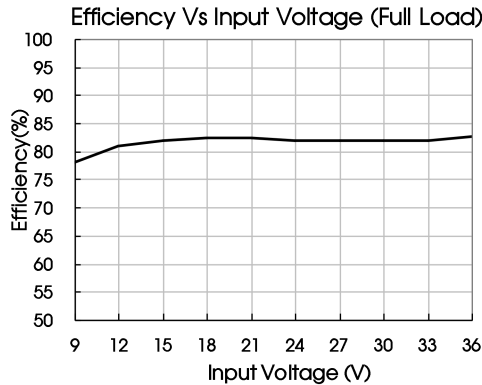

Fig. 1



Design Reference

1. Typical application

All the DC/DC converters of this series are tested before delivery using the recommended circuit shown in Fig. 2.

Input and/or output ripple can be further reduced by appropriately increasing the input & output capacitor values  $C_{in}$  and  $C_{out}$  and/or by selecting capacitors with a low ESR (equivalent series resistance). Also make sure that the capacitance is not exceeding the specified max. capacitive load value of the product.

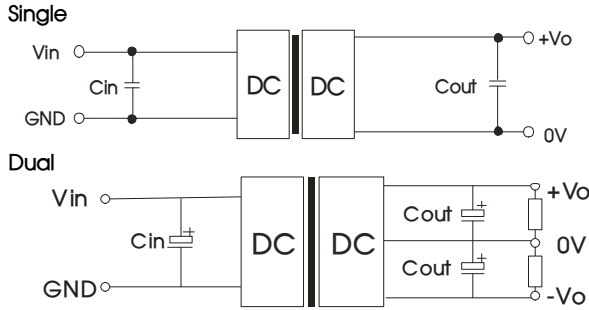

Fig. 2

Vin(VDC)	Cin	Vo(VDC)	Cout
24	100µF/50V	±5/3.3/5/9	10µF/16V
		±12/±15/12/15	10µF/25V
		24/25	10µF/50V
48	10µF/100V - 47µF/100V	3.3/5	10µF/16V
		12/15	10µF/25V
		24	10µF/50V

2. EMC compliance circuit

URE\_P-6WR3 & URF\_P-6WR3:

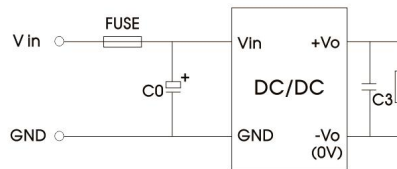
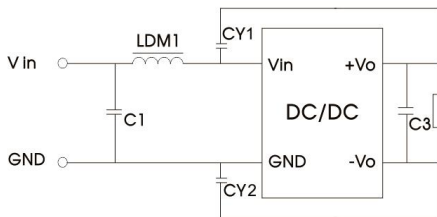

Fig. 3-①

URE\_P-6WR3:



URF\_P-6WR3:

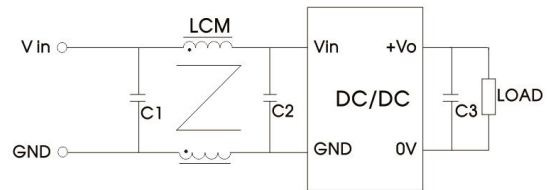

Fig. 3-②

Notes: For EMC tests we use Part ① in Fig. 3 for immunity and part ② for emissions test. Selecting based on needs.

Parameter description

URE_P-6WR3	
Model	Vin: 24VDC
FUSE	Choose according to actual input current
C0	1000µF/50V
C1	1µF/50V
C3	Refer to the Cout in Fig.2
LDM1	4.7µH
CY1/CY2	1nF/3kV

Parameter description

URF_P-6WR3		
Model	Vin: 24VDC	Vin: 48VDC
FUSE	Choose according to actual input current	
C0	1000µF/50V	680µF/100V
C1/C2	2.2µF/50V	2.2µF/100V
LCM	2.2 mH, recommended to use MORNSUN's FL2D-30-222	
C3	Refer to the Cout in Fig.2	

3. The products do not support parallel connection of their output

4. For additional information please refer to DC-DC converter application notes on

[www.mornsun-power.com](http://www.mornsun-power.com)

Dimensions and Recommended Layout

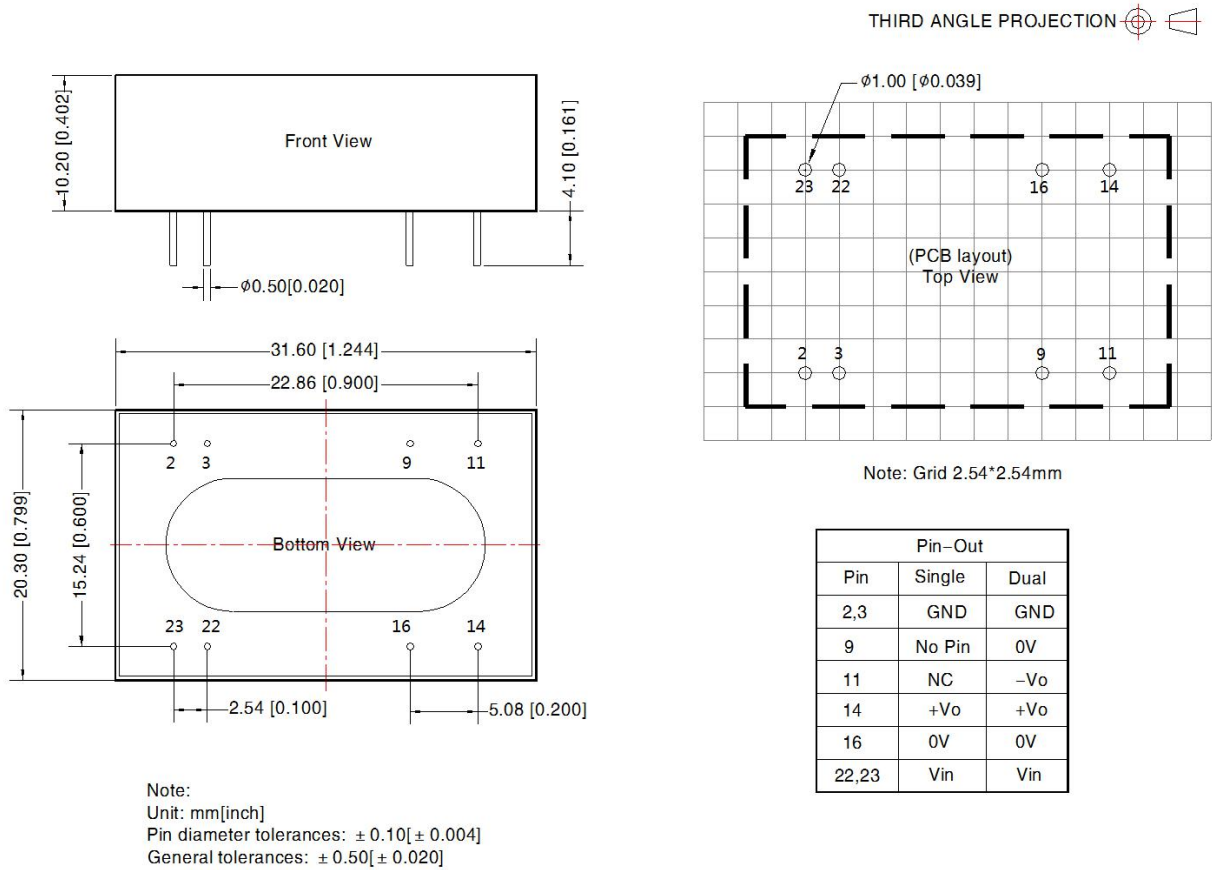

Pin	Pin-Out	
	Single	Dual
2,3	GND	GND
9	No Pin	0V
11	NC	-Vo
14	+Vo	+Vo
16	0V	0V
22,23	Vin	Vin

- Note:
- For additional information on Product Packaging please refer to [www.mornsun-power.com](http://www.mornsun-power.com). Packaging number: 58210008;
  - The maximum capacitive load offered were tested at input voltage range and full load;
  - Unless otherwise specified, parameters in this datasheet were measured under the conditions of  $T_a=25^\circ\text{C}$ , humidity<75%RH with nominal input voltage and rated output load;
  - The recommended unbalance degree of the dual output module load is  $\leq \pm 5\%$ ; if the degree exceeds  $\pm 5\%$ , than the product performance cannot be guaranteed to comply with all parameters in the datasheet. Please contact our technicians directly for specific information;
  - All index testing methods in this datasheet are based on our company corporate standards;
  - The performance indexes of the product models listed in this datasheet are as above, but some indexes of non-standard model products will exceed the above-mentioned requirements, and please directly contact our technicians for specific information;
  - We can provide product customization service;
  - Products are related to laws and regulations: see "Features" and "EMC";
  - Our products shall be classified according to ISO14001 and related environmental laws and regulations, and shall be handled by qualified units.

Mornsun Guangzhou Science & Technology Co., Ltd.

Address: No. 5, Kehui St. 1, Kehui Development Center, Science Ave., Guangzhou Science City, Huangpu District, Guangzhou, P. R. China  
 Tel: 86-20-38601850 Fax: 86-20-38601272 E-mail: [info@mornsun.cn](mailto:info@mornsun.cn) [www.mornsun-power.com](http://www.mornsun-power.com)