

N-Channel Enhancement Mode MOSFET

Feature

- 25V/0.71A, $R_{DS(ON)} = 400\text{m}\Omega(\text{MAX})$ @ $V_{GS} = 4.5\text{V}$.
 $R_{DS(ON)} = 450\text{m}\Omega(\text{MAX})$ @ $V_{GS} = 2.7\text{V}$.
- Super High dense cell design for extremely low $R_{DS(ON)}$.
- ESD Protection HBM >1KV
- SOT-23 for Surface Mount Package.

Applications

- Power Management
- Portable Equipment and Battery Powered Systems.

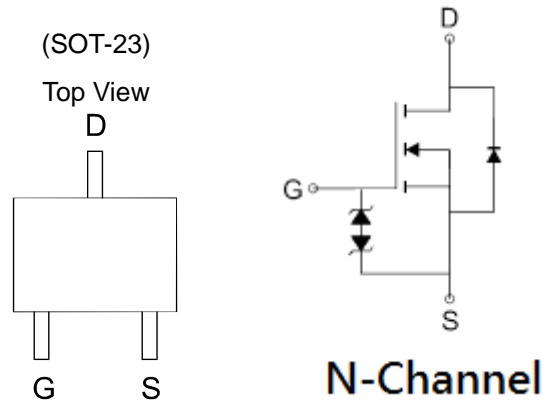

Absolute Maximum Ratings $T_A=25^\circ\text{C}$ Unless Otherwise noted

Parameter	Symbol	Limit	Units
Drain-Source Voltage	V_{DS}	25	V
Gate-Source Voltage	V_{GS}	± 8	V
Drain Current-Continuous	I_D	0.71	A

Electrical Characteristics $T_A=25^\circ\text{C}$ Unless Otherwise noted

Parameter	Symbol	Test Conditions	Min	Typ.	Max	Units
Off Characteristics						
Drain to Source Breakdown Voltage	BVDSS	$V_{GS}=0\text{V}, I_D=250\mu\text{A}$	25	-	-	V
Zero-Gate Voltage Drain Current	IDSS	$V_{DS}=25\text{V}, V_{GS}=0\text{V}$	-	-	1	μA
Gate Body Leakage Current, Forward	IGSSF	$V_{GS}=8\text{V}, V_{DS}=0\text{V}$	-	-	10	nA
Gate Body Leakage Current, Reverse	IGSSR	$V_{GS}=-8\text{V}, V_{DS}=0\text{V}$	-	-	-10	nA
On Characteristics						
Gate Threshold Voltage	$V_{GS(th)}$	$V_{GS}=V_{DS}, I_D=250\mu\text{A}$	0.5	-	1.0	V
Static Drain-source On-Resistance	$R_{DS(ON)}$	$V_{GS}=4.5\text{V}, I_D=2\text{A}$	-	300	400	$\text{m}\Omega$
		$V_{GS}=2.5\text{V}, I_D=1.5\text{A}$	-	340	450	$\text{m}\Omega$
Drain-Source Diode Characteristics and Maximum Ratings						
Drain-Source Diode Forward Voltage	VSD	$V_{GS}=0\text{V}, I_S=0.94\text{A}$		0.8	1.2	V

Typical Characteristics

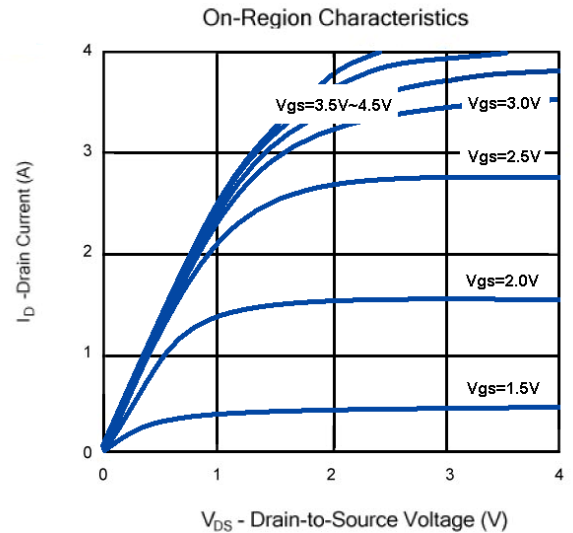
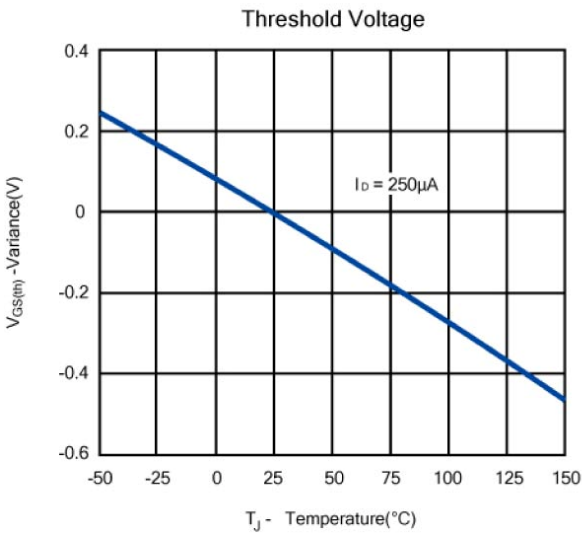
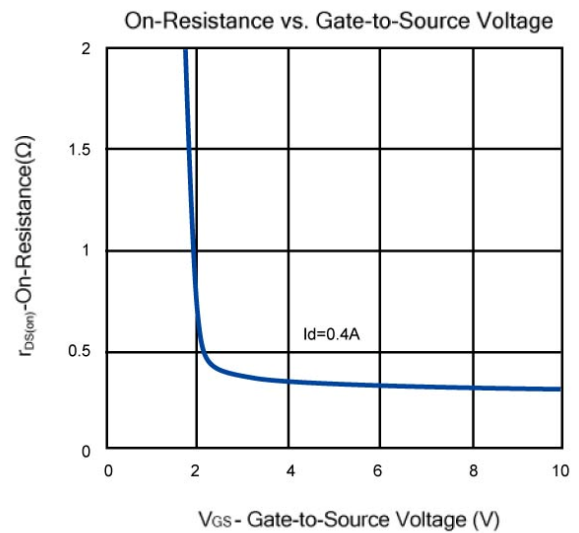
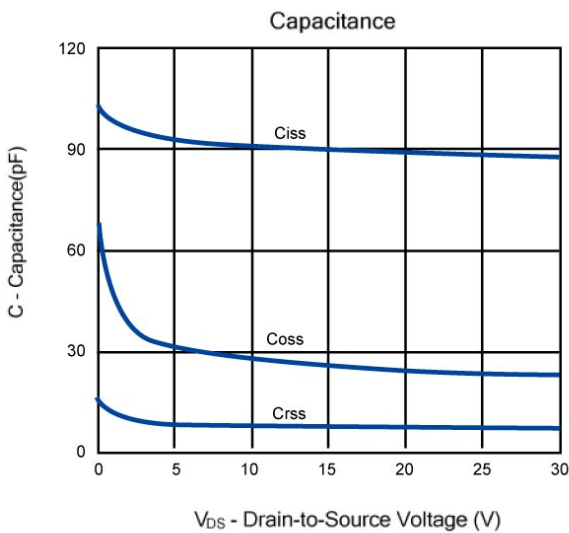
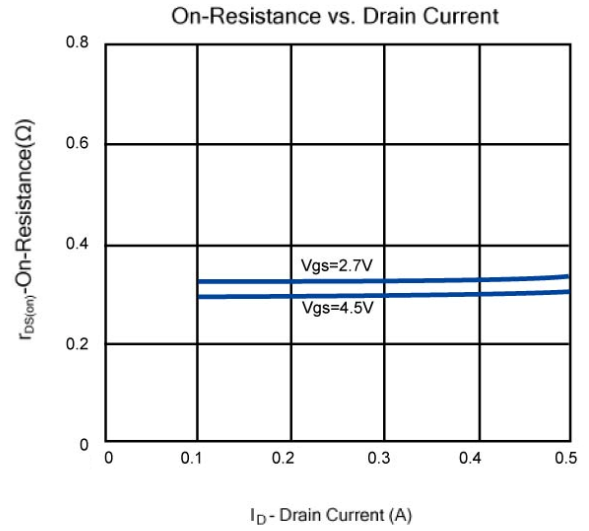
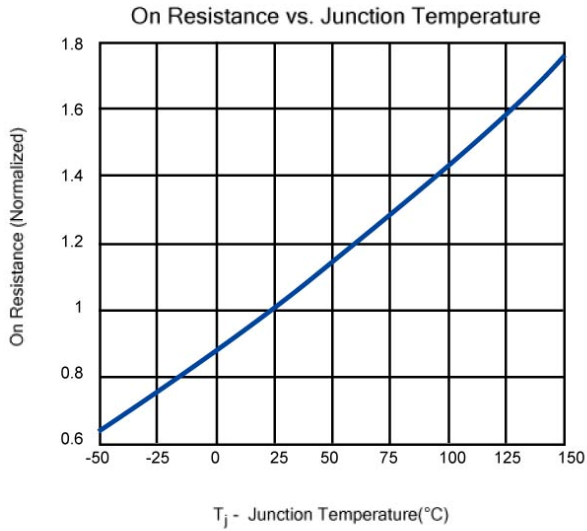

Typical Characteristics

