

Data sheet

Commercial Art.No.: 70.060.2428.0

Data cable entry IT DKE 24

Data cable feed-through with 4 bushings, size 24



Commercial Art.No.	70.060.2428.0
EAN	4015573699045
Order Unit	5

Technical data

General

Color	Grey
Surface	With powder coating
Locking mechanism	Double locking levers
Housing material	aluminum
Operating temperature range min.	-40 °C
Operating temperature range max.	100 °C
Construction	24
Degree of protection (IP)	IP65
Number of cable feed-throughs, connection range 4,5 - 10 mm	2
Number of cable feed-throughs, connection range 9 - 15 mm	2

Classification

ECLASS 11	
ECLASS 8.1	27440202
ETIM 7.0	EC000437
ETIM 6.0	EC000437
ETIM 5.0	EC000437

Product compliance

ROHS conformity status	Compliant
REACH-SVHC conformity status	Compliant

A Weitergabe sowie Vervielfältigung dieses Dokuments, Verwertung und Mitteilung seines Inhalts sind verboten, soweit nicht ausdrücklich gestattet. The reproduction, distribution and utilization of this document as well as the communication of its contents to others without express authorization is prohibited.

B These dimensions will be especially checked at delivery

C Only inspection dimensions

D With /E marked dimensions are only valid for internal use

E Diese Maße werden bei Abnahme besonders geprüft

F Ausschließlich Prüfmaße

MIT /E gekennzeichnete Maße sind nur für interne Zwecke gültig

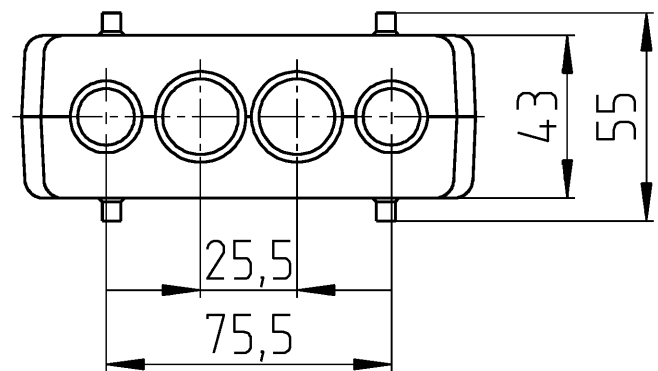
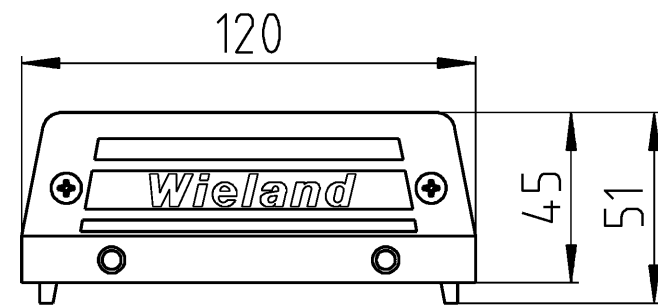
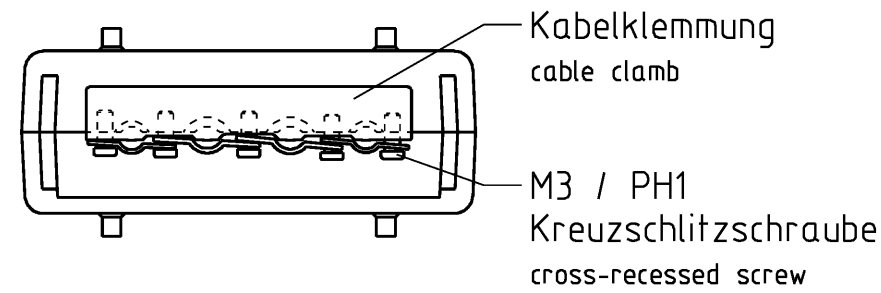

70.060.2428.0

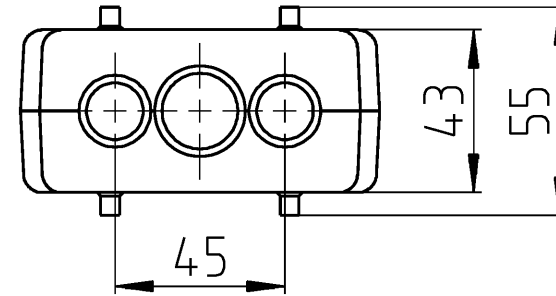
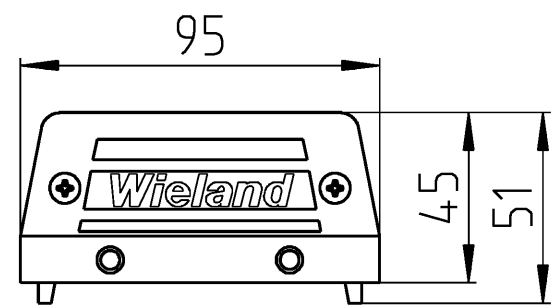

70.060.1628.0

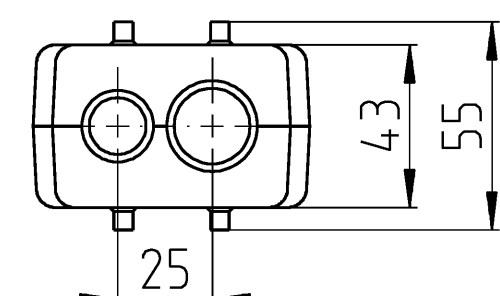
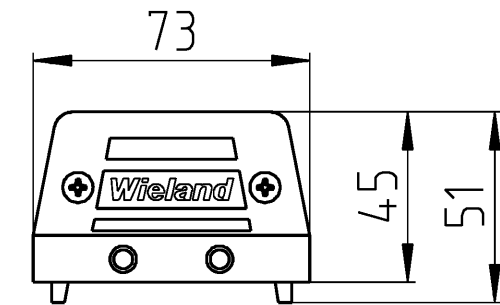

70.060.1028.0

70.060.2428.0	IT DKE 24	Durchführung 2x 4,5-10mm und 2x 9-15mm bushing for cable-I 2x 4,5-10mm nd 2x 9-15mm
70.060.1628.0	IT DKE 16	Durchführung 2x 4,5-10mm und 1x 9-15mm bushing for cable-I 2x 4,5-10mm nd 1x 9-15mm
70.060.1028.0	IT DKE 10	Durchführung 1x 4,5-10mm und 1x 9-15mm bushing for cable-I 1x 4,5-10mm nd 1x 9-15mm
Bestellnummer /Order number	Typ /Type	Varianten /Variants
Weitere Daten siehe KATALOG oder eKatalog. Additional data see CATALOG or eCatalog.		www.wieland-electric.com eshop.wieland-electric.com

Gummidichtungen im Lieferumfang enthalten
rubber gaskets in the scope of supply contain

frei von lackbenetzungsstörenden Substanzen
free from paint binding inhibitor substances

Pulverbeschichtet silbergrau, ähnl. RAL 7001
powder-coated, silver-grey similar to RAL 7001

Tolerierung Size ISO 14405 © / Tolerance system Size ISO 14405 ©. (This ISO-standard describes the envelope principle. According to the envelope principle the deviations of form and parallelism are limited by the size tolerances).		ja/yes <input checked="" type="checkbox"/> Stoffverbots- und Deklarationsliste nach WN 5020.010 ist einzuhalten. Conformity with Wieland document WN 5020.010 e (list of prohibited / declarable hazardous substances) to be declared!	
Freitoleranz nach General tolerance		CAD - Zeichnung, keine manuellen Änderungen CAD - drawing, no manual modifications allowed	1 Verwendung: First Use:
Blatt: 1 von 1 Sheet: 1 of 1		Zeichnung Nr. / Drawing No.	
Werkstoff / Material		Tag/Date	Name
Maßstab / Scale		gezeichnet drawn	11.07.2017 Dutsch T.
1:2		geprüft checked	
Vol. mm ³ / fl./Srf. mm ²		Normgepr. Stand. check	
Ersatz für / Replacement for:		Maße in mm / Dimensions are in mm	
www.wieland-electric.com		Type	Benennung/Title
IT DKE		GEHAEUSEOBERTHEIL	
Index Datum / Blatt Date / Sheet		Datenkabeleinführung data cable feed through	
Änderung / Revision			

Weitergabe sowie Vervielfältigung dieses Dokuments, Verwertung und Mitteilung seines Inhalts sind verboten, soweit nicht ausdrücklich gestattet. The reproduction, distribution and utilization of this document as well as the communication of its contents to others without express authorization is prohibited.