



## Features

- Shielded construction
- Iron powder core
- High saturation current
- Inductance range: 0.33 to 15  $\mu$ H
- Rated current up to 14 A
- RoHS compliant\* and halogen free\*\*

## Applications

- DC/DC converters
- Power supplies for:
  - Portable communications equipment
  - Laptop computers
  - Camcorders, HDTV, car audio systems
  - Video game consoles

# SRP5030T Series - Shielded Power Inductors

## Electrical Specifications

Bourns Part No.	Inductance L ( $\mu$ H) $\pm 20\%$	DCR ( $m\Omega$ ) Max.	I rms (A)	I sat (A)
SRP5030T-R33M	0.33	5	14	18
SRP5030T-R47M	0.47	7.4	12	16
SRP5030T-R68M	0.68	12	8.5	14
SRP5030T-1R0M	1.0	14	7	11
SRP5030T-1R2M	1.2	16	6.5	11
SRP5030T-1R5M	1.5	25	6	10
SRP5030T-2R2M	2.2	35	5.5	9
SRP5030T-3R3M	3.3	38	5	8
SRP5030T-4R7M	4.7	53	4.6	6
SRP5030T-5R6M	5.6	63	4.25	4.5
SRP5030T-6R8M	6.8	76.2	4	4.3
SRP5030T-100M	10	128	2.75	3.5
SRP5030T-150M	15	190	2.1	2.6

## Soldering Profile

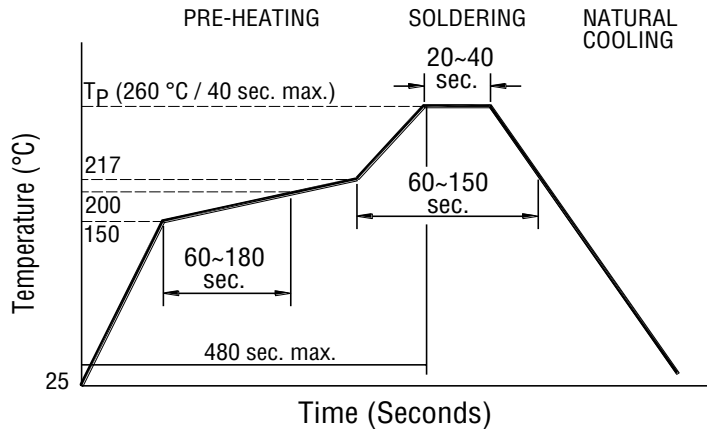

## General Specifications

Test Voltage ..... 1.0 V  
 Test Frequency ..... 100 KHz  
 Operating Temperature ..... -40  $^{\circ}$ C to +125  $^{\circ}$ C  
 (Temperature rise included)  
 Storage Temperature ..... -40  $^{\circ}$ C to +125  $^{\circ}$ C  
 Resistance to Soldering Heat ..... +260  $^{\circ}$ C, 40 sec. max.

## Materials

Core ..... Iron powder  
 Wire ..... Enameled copper  
 Terminal ..... Sn  
 Rated Current ..... Ind. drops 20 % typ.  
 at I<sub>sat</sub>  
 Temperature Rise ..... 40  $^{\circ}$ C typ.  
 at rated I<sub>rms</sub>  
 Packaging ..... 2000 pcs. per 13-inch reel

## Product Dimensions

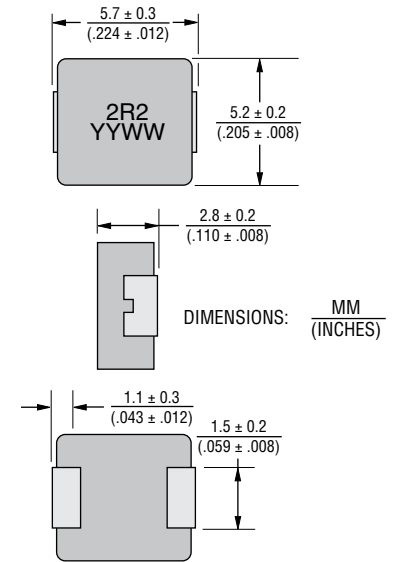

## Recommended Layout

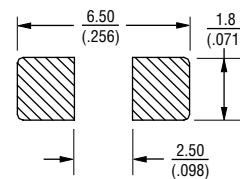

## Electrical Schematic

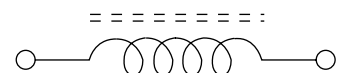

\* RoHS Directive 2002/95/EC Jan. 27, 2003 including annex and RoHS Recast 2011/65/EU June 8, 2011.

\*\* Bourns follows the prevailing definition of "halogen free" in the industry. Bourns considers a product to be "halogen free" if (a) the Bromine (Br) content is 900 ppm or less; (b) the Chlorine (Cl) content is 900 ppm or less; and (c) the total Bromine (Br) and Chlorine (Cl) content is 1500 ppm or less.

Specifications are subject to change without notice.

The device characteristics and parameters in this data sheet can and do vary in different applications and actual device performance may vary over time.

Users should verify actual device performance in their specific applications.

# SRP5030T Series - Shielded Power Inductors

**BOURNS®**

## L vs. I Charts

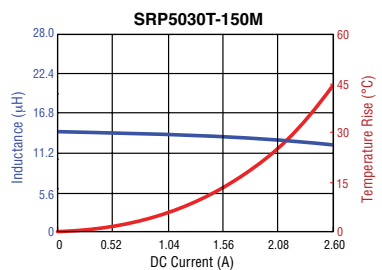
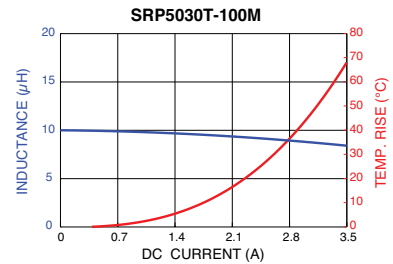
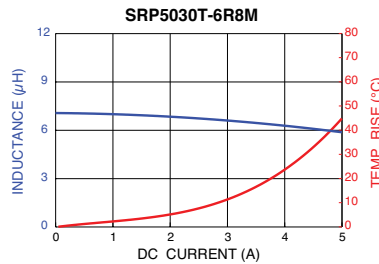
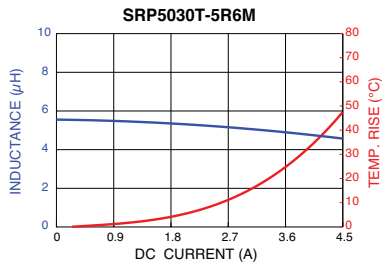
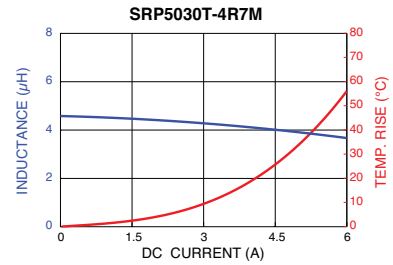
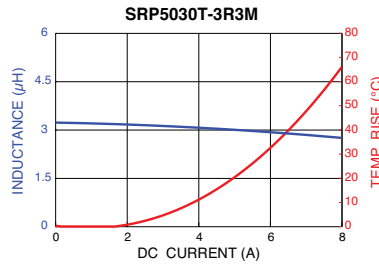
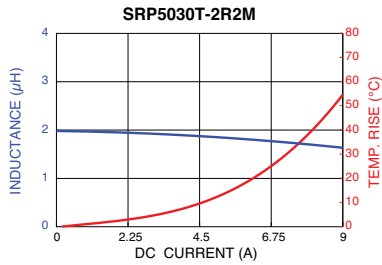
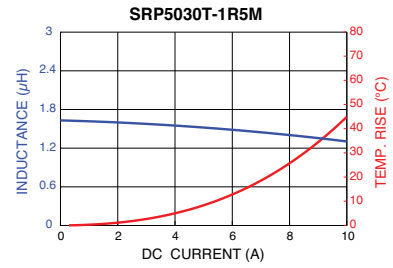
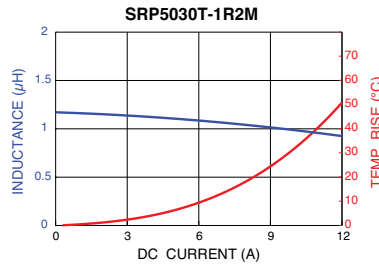
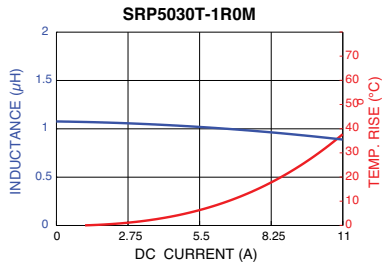
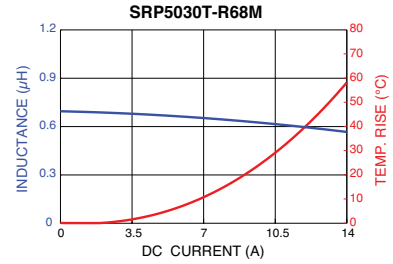
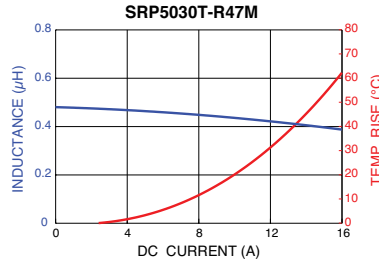
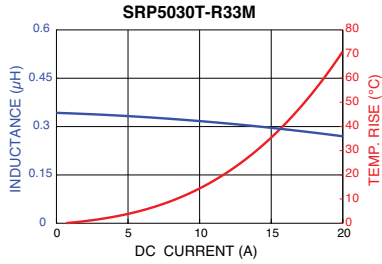

Specifications are subject to change without notice. The device characteristics and parameters in this data sheet can and do vary in different applications and actual device performance may vary over time. Users should verify actual device performance in their specific applications.

# SRP5030T Series - Shielded Power Inductors

**BOURNS®**

## Packaging Specifications

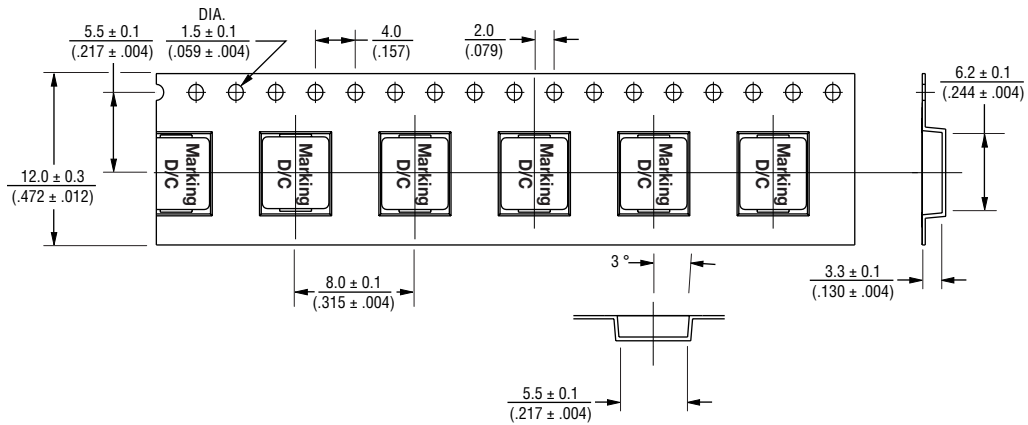
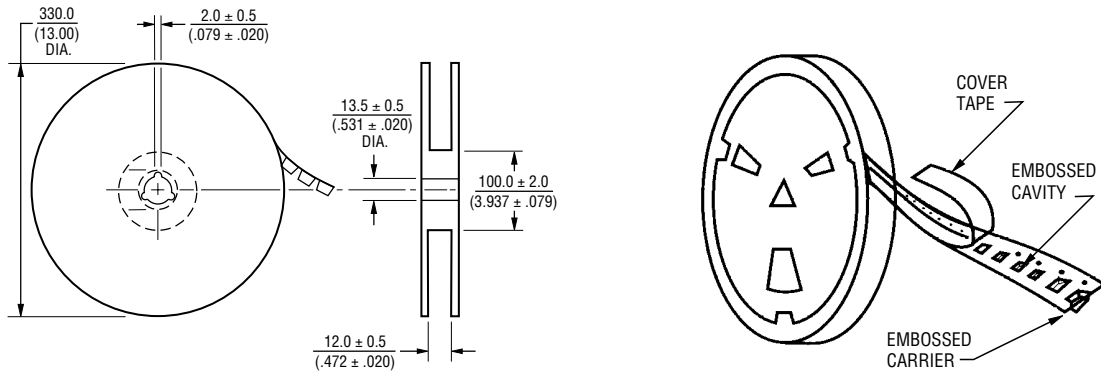

USER DIRECTION OF FEED →  
2000 PIECES PER REEL

DIMENSIONS:  $\frac{\text{MM}}{\text{(INCHES)}}$

**BOURNS®**

Asia-Pacific: Tel: +886-2 2562-4117 • Fax: +886-2 2562-4116

EMEA: Tel: +36 88 520 390 • Fax: +36 88 520 211

The Americas: Tel: +1-951 781-5500 • Fax: +1-951 781-5700

[www.bourns.com](http://www.bourns.com)