

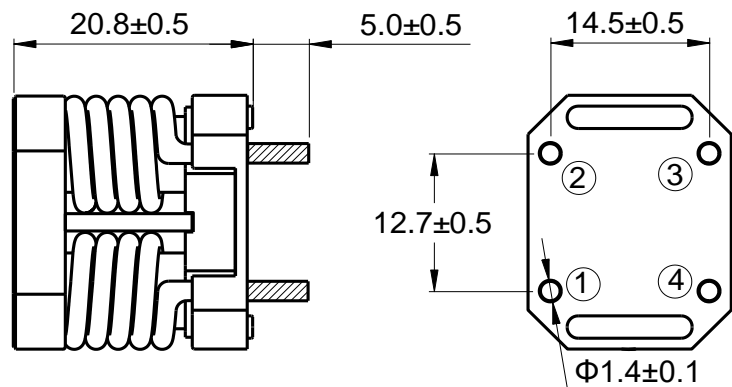

Outline: 产品概要

- Excellent impedance characteristics, making it great for suppressing common mode noise.
高阻抗特性，能高效抑制共模噪音效果。
- Measures against common mode noise in power lines for various DC power lines, multimedia devices, and various electronic devices, including automotive power trains.
各种电子产品、多媒体设备，包括车载动力传递的 DC 电源线的共模噪音抑制。
- Operating temperature : -40°C ~ +125°C (Including coil's temperature rise)
工作温度：-40°C~+125°C (包含线圈发热)

1 Appearance and Dimensions (mm) 外形尺寸 (mm)

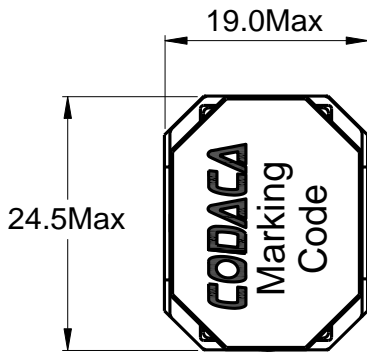

2 Marking 印字标识



3 Reference Hole Pattern (mm) 参考焊孔尺寸 (mm)

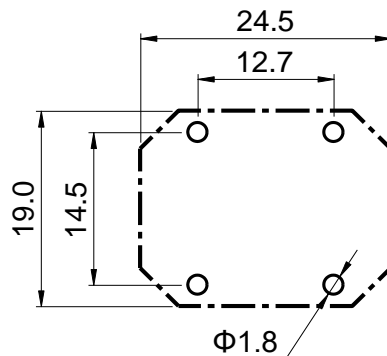

4 Schematic 原理图

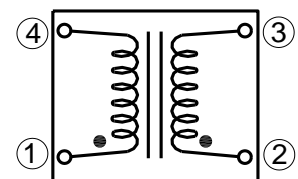

5 Electrical Characteristics

电气特性

Part No. 型号	Inductance (μH) 电感值 ※1	D.C.R. ($\text{m}\Omega$) 直流电阻		Rated Current (A) 额定电流 ※2
	Min	Typical	Max	Typical
CPTR2420-121	120	2.08	2.40	22.0

■ All data is tested based on 25°C ambient temperature.

所有数据基于环境温度 25°C 条件下测试。

※1 Inductance measure condition at 100kHz, 0.1V.

电感测试条件为 100kHz, 0.1V。

※2 Rated current: the value of DC current when the temperature rise is $\Delta T 40^\circ\text{C}$ ($T_a=25^\circ\text{C}$).

额定电流: 使产品温度上升到 $\Delta T 40^\circ\text{C}$ 时所加载的直流电流值 ($T_a=25^\circ\text{C}$)。

※ Special remind: Circuit design, component placement, PCB size and thickness, cooling system and etc. all will affect the product temperature. Please verify the product temperature in the final application.

特别提醒: 线路设计, 组件布局, 印刷电路板 (PCB) 尺寸及厚度, 散热系统等均会影响产品温度。

请务必在最终应用时, 验证产品发热状况。

6 Temperature Rise Current Curve

温升电流曲线

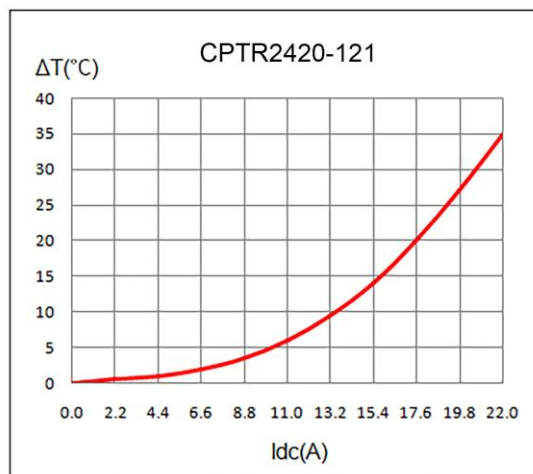

7 Packing specification

包装规格

7.1 Plastic tray dimensions (mm)

吸塑盘尺寸

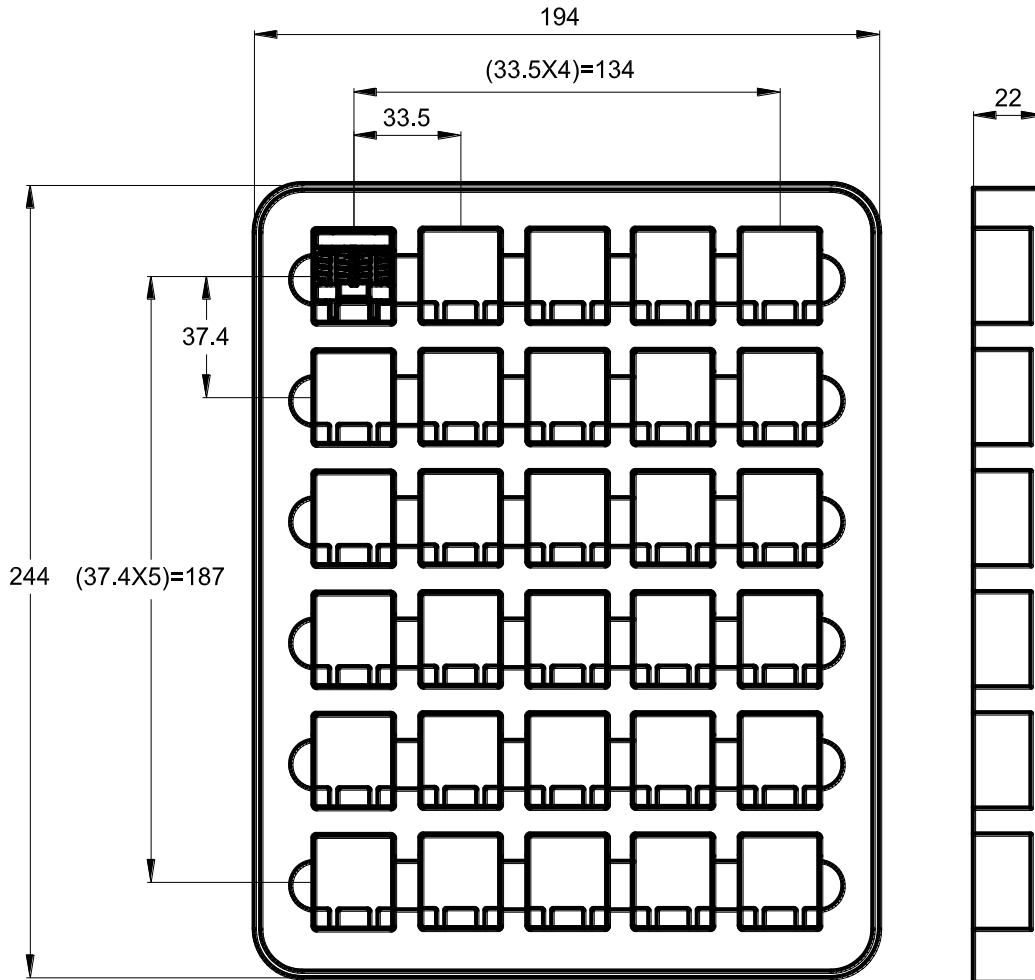

7.2 Packing 包装

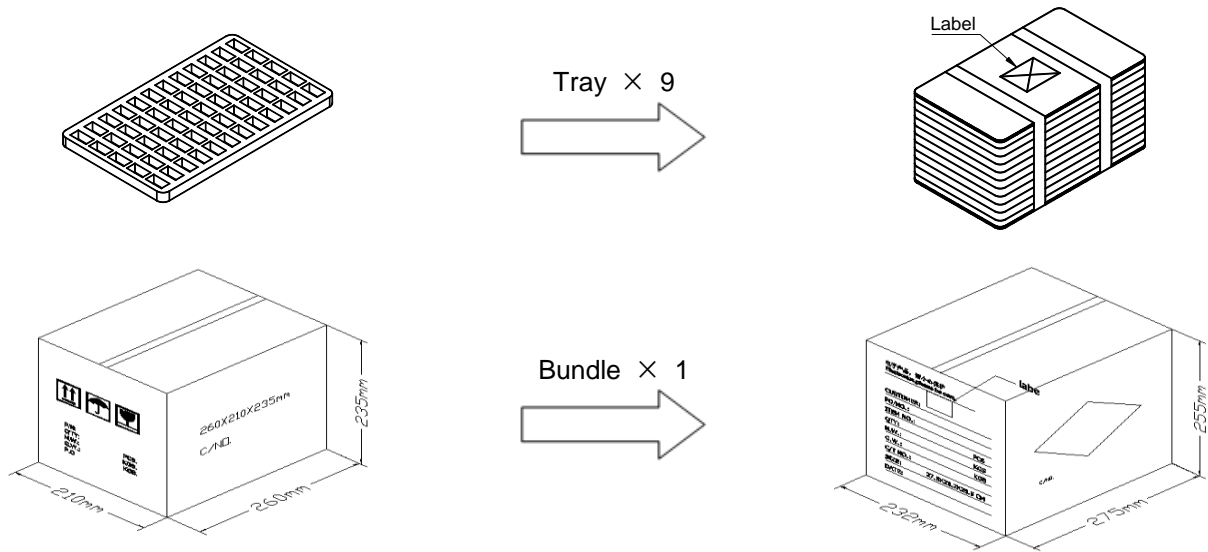

7.3 Carton dimensions and packing quantity 包装箱尺寸和包装数量

■ Inner Carton : 260×210×235mm
内包装箱

■ Out Carton : 275×232×255mm
外包装箱

Product Series 产品系列	Quantity / Tray 数量 / 盘	Quantity / Bundle 数量 / 捆	Out Carton Quantity 外箱 包装总数量
CPTR2420	30pcs	(30 × 9) = 270pcs	(270 × 1) = 270pcs

7.4 Label making 标签标识

The following items will be marked on the tray of product label and shipping label.
以下项目将明确标识于产品吸塑盘标签以及运输标签上。

Production Label 产品标签
■ Packing No. 包装流水号
■ Quantity 数量
■ Shipment Date 出货日期
■ Part No. 产品型号
■ Customer Part No. 客户型号
■ Customer Po No. 客户订单号

Shipping Label 运输标签
■ Packing No. 包装流水号
■ Quantity 数量
■ Shipment Date 出货日期
■ Part No. 产品型号
■ Customer Part No. 客户型号
■ Customer Po No. 客户订单号

8 Notice of Use**使用注意事项**

8.1 Product in packing storage condition : temperature 5~40°C, RH≤70%.

产品在包装中的保存条件：温度 5~40°C，相对湿度小于等于 70%。

If taking out for use, the remaining products should be sealed in plastic bags and preserved in accordance with the above conditions, to avoid oxidation of terminals (electrodes), affecting soldering status.

如果取出使用，剩余的产品请用胶袋密封按照以上条件保存，避免端子(电极)氧化，影响焊接状态。

8.2 A storage of Codaca Electronic products for longer than 12 months is not recommended, Within other effects, the terminals may suffer degradation, resulting in bad solderability. Therefore, all products shall be used within the period of 12 months based on the day of shipment.

科达嘉电子产品储存期不建议超过 12 个月，在其他影响下，端子可能会退化，导致焊接性差。

因此，所有产品应使用在 12 个月内以出货日为基础。

8.3 Do not keep products in unsuitable storage conditions, such as areas susceptible to high temperatures, high humidity, dust or corrosion.

请不要将产品保存于高温、高湿、有尘埃、腐蚀性气体的不适合环境中。

8.4 Always handle products with care.

请小心轻放，避免由于产品的跌落或取用不当而引致的损坏。

8.5 Don't touch electrodes directly with bare hands as oil secretions may inhibit soldering.

Always ensure optimum conditions for soldering.

手上的油脂会导致可焊性降低，应避免用手直接接触端子。

8.6 When this product will be used on a similar or new project to the original one, sometimes it might be unable to satisfy the specifications due to different condition of usage.

当本产品应用于相似或新的产品上时，电性可能因使用条件的不同而与规格产生一定出入。

8.7 This inductor itself does not have any protective function in abnormal condition, such as overload, short-circuit, open-circuit conditions, etc. Therefore, it shall be confirmed that there is no risk of smoke, fire, dielectric withstand voltage, insulation resistance, etc., or use in abnormal conditions protective devices or protection circuit in the end product.

在过载、短路、开路等不正常条件下，本电感产品无任何自我保护功能。

因此，请确保产品使用中不含烟、火、高压、绝缘等危险使用条件，或使用在不正常条件下的保护作用装置或电路中。

8.8 Hi-Pot test with higher voltage than spec value will damage insulating material and shorten its life.

高电压绝缘测试会对本产品绝缘材料造成损伤，并缩短产品寿命。

8.9 If using in potting compound, the magnet wire coating might be damaged, please consult with us.

如果将本产品用于埋制复合组件，有可能会对本产品的金属线表层造成腐蚀，请咨询本公司。

8.10 Refrain from rinsing coils. If necessary, please consult with us.

请不要清洗产品，如果需要清洗，请咨询本公司。