

SECTION B-B

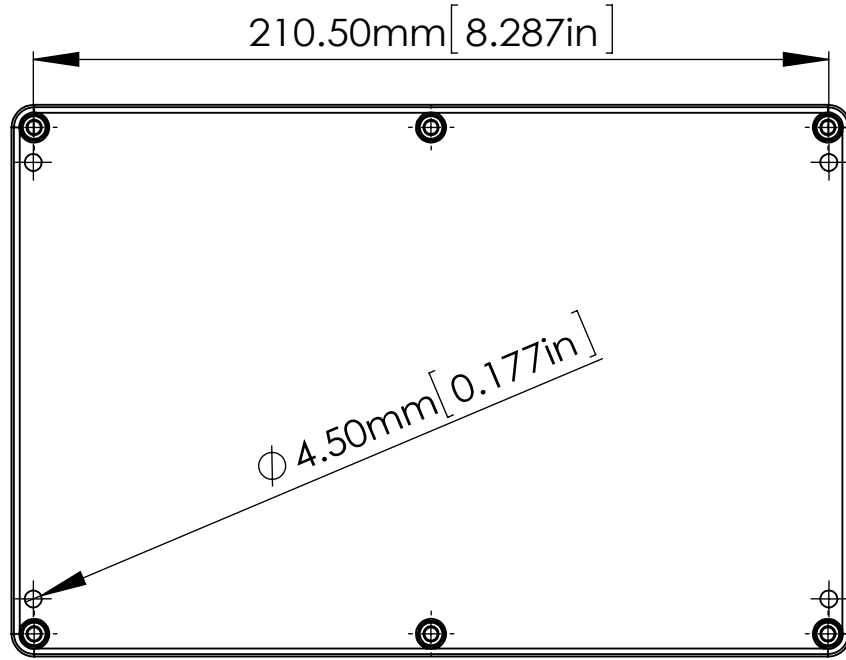

M4X8 LG,THREADED INSERT(6) PLACES.  
M3X5 LG,THREADED INSERT(4) PLACES.

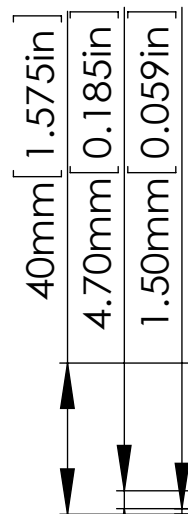

SECTION A-A

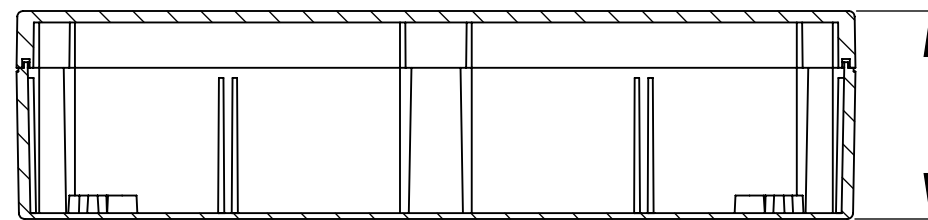

ASSEMBLY

According to ISO 2768-m	
Measuring DIM=L	Tolerances
0.5<L<=3.0mm	±0.1mm
3.0<L<=6.0 mm	±0.1mm
6.0<L<=30.0 mm	±0.2mm
30.0<L<=120.0 mm	±0.3mm
120.0<L<=400.0 mm	±0.5mm
400.0<L<=1000.0 mm	±0.8mm

宣又實業有限公司  
GAINTA INDUSTRIES LTD.

繪圖 DRA'D BY  
JACKY

日期 DATE  
2018/05/02

材質 MATE.  
PC/ABS

圖名TITLE:  
G218;G317

圖號DWG NO:

版次REVISED:  
F